

job name:
 type:

mere™ ceiling spec sheet

driver housing / power head

extruded aluminum with silver anodized or black anodized finish, acts as heat sink as well.

diffuser

6" dia. .100" virgin matte white acrylic cylinder.

bottom lens (optional)

P95 frosted acrylic bottom lens solvent welded to bottom of cylindrical diffuser.

modular construction

integrated solder-less holder provides superior connectivity and allows for LED module replacement in the field. modular fixture design allows driver to be replaced in the field.

LED module

COB array in 2700K, 3000K, 3500K, or 4000K. (call factory for 5000K) (80+ cri standard) optional 90cri (see below). under normal operating conditions, the LEDs employed are rated for >50,000hrs L70 (6.8K) per IES TM-21 from LM-80 test data.

driver

integral, programmable, UL class P, class 2, universal input (120-277v), constant current, 0-10v dimming, 1% minimum dimming level, PF >.9, THD <20%, protections include open and short circuit, overload and over temperature.

mounting

mounts to standard j-box (by other).

emergency

recommend use of inverter (by other).

optional WREM: wired for remote EM battery (by other). if using WHPC, SBPC, or BKPC cords, 2nd power cord required.



catalog number

--	--	--	--	--

size

C2519
6" dia X 19"ht

C2528
6" dia X 28"ht

CCT

27 2700K

30 3000K

35 3500K

40 4000K

lumens

FX 1660 lm

LO 2300 lm

HI 3200 lm

HX 4100 lm

CL* xxxx lm
* custom lumens
consult factory

anodized finishes

AN silver anodized

ANB anodized black

painted finish

BS brass

BU blue

BZ bronze

CP champagne

GM gun metal

MB military blue

MW matte white

OR orange

RD red

SS satin silver

TG textured gray

YO yellow

premium finish

RAL specify RAL#

options

90CRI

BL frosted acrylic bottom lens, solvent welded.

WREM wired for remote EM battery pack (by other) (see note above)



made in the
usa!

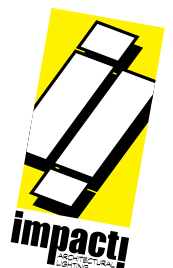

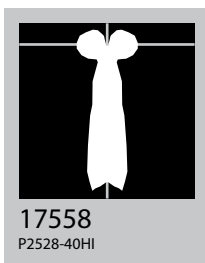
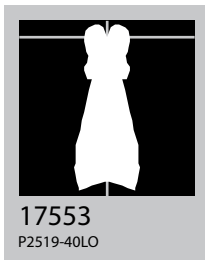
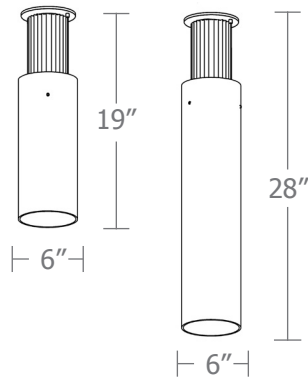

Cat No	Delivered Lumens*	Watts		Amps	
		120V / 277V	120V	277V	
C2519 FX	1660	14	.12	.05	
C2519 LO	2300	20	.17	.07	
		ies file # 17553			
C2519 HI	3200	29	.24	.10	
C2519 HX	4100	38	.32	.14	
C2528 FX	1660	14	.12	.05	
C2528 LO	2300	20	.17	.07	
C2528 HI	3200	29	.24	.10	
		ies file # 17558			
C2528 HX	4100	38	.32	.14	

*delivered lumens based on 4000K, 80+ cri (90cri multiplier .83)
BL multiplier .90

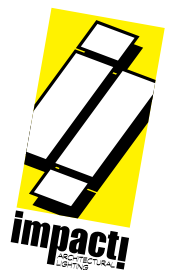

Powder Coat Paint Finishes

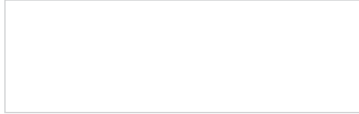

MW matte white



SS satin silver

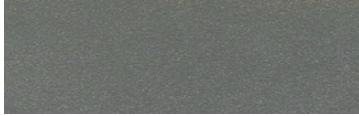

TG textured gray



CP champagne

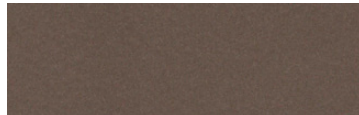

BZ bronze

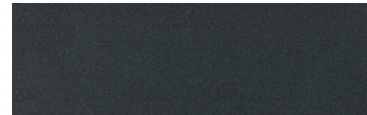

GM gun metal



OR orange 2011



BU blue 5017



BS brass



RD red 3020



YO yellow 1018



MB military blue

For accurate color verification, actual finish samples are available upon request.

Premium Finishes*



RAL#

*Available on select series. Consult product submittal for availability.

