

job name:
 type:

incit™ spec sheet

material

trim ring
 precision CNC spun .063" aluminum. rolled top edge for added strength and recessed dome plane eliminates visible mounting hardware.

diffuser
 .125" virgin matte white acrylic dome.

optics

reflector
 segmented .050 aluminum painted high reflectance powder coat matte white.

internal dust shield
 .125" P95 frost acrylic lens provides debris-free diffuser illumination.

top lens
 .125" clear acrylic with prepainted white aluminum center disc reflector, protects LEDs while gently illuminating the dome/diffuser.

LED

custom LED board in 3000K, 3500K, or 4000K (80+ cri standard) optional 90cri (see below). under normal operating conditions, the LEDs employed are rated for >50,000hrs L70 (6.8K) per IES TM-21 from LM-80 test data. white power cord is standard with other color options listed below.

driver

integral, programmable, UL class P, class 2, universal input (120-277v), constant current, 0-10v dimming, 1% minimum dimming level, PF >.9, THD <20%, protections include open and short circuit, overload and over temperature.

mounting

5"dia. spun steel canopy in satin white with sloped ceiling adapter. single 12' stainless steel cable connects to field adjustable collector. an array of cables branch off and attach to reflector with adjustable grippers. cable system allows for exact AFF mounting heights.

emergency

recommend use of inverter (by other).
 optional WREM: wired for remote EM battery (by other). 2nd power cord required.



catalog number

--	--	--	--

size	LED array	finish	options
P1026 (2ft) 26"dia X 5.75"ht	30FX 3000K 30LO 3000K 30HI 3000K	AP anodized paint BN brown BR brick red BS brass BU blue BZ bronze CP champagne FB flat black GM gun metal GR green MB military blue MN mint MW matte white OR orange PL purple RD red SB satin black SS satin silver TG textured gray TW textured white YO yellow	SBPC Silver braid power cord and white canopy 90CRI WREM wired for remote EM battery pack (by other) (see note above)
P1038 (3ft) 38"dia X 7.75"ht	35FX 3500K 35LO 3500K 35HI 3500K 40FX 4000K 40LO 4000K 40HI 4000K CL xxxx lm custom lumens consult factory	premium finish BA brushed aluminum RAL specify RAL#	

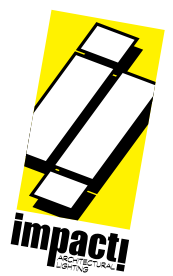

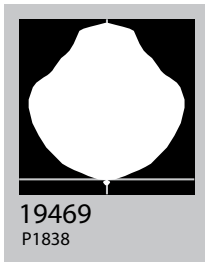
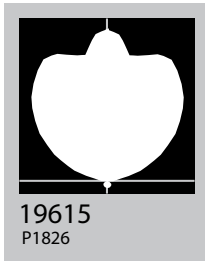
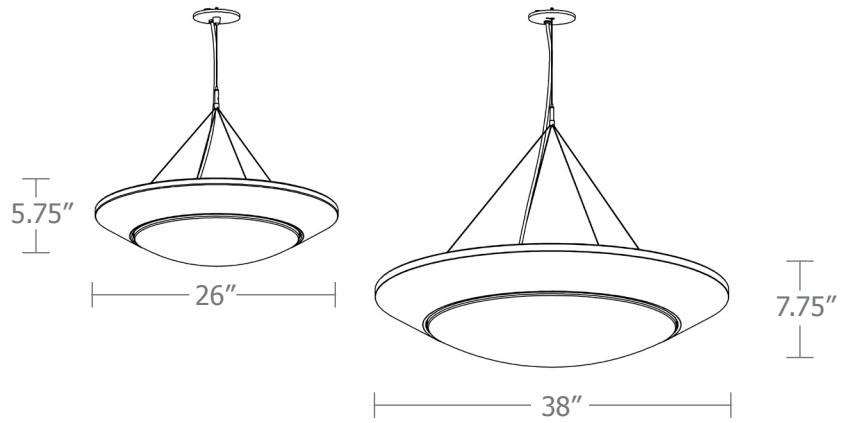

Cat No Delivered* Lumens **Watts** 120V / 277V **Amps** 120V 277V

Cat No	Delivered* Lumens	Watts 120V / 277V	Amps 120V	Amps 277V
P1026 FX	1690	15	.13	.05
P1026 LO	3470	29	.24	.10
P1026 HI	6701	57	.48	.21
ies file # 19615				
P1038 FX	3385	29	.24	.10
P1038 LO	6580	57	.48	.21
P1038 HI	13165	113	.94	.41
ies file # 19469				

*delivered lumens based on 4000K, 80+ cri
(90cri multiplier .83)

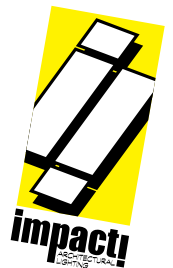

Powder Coat Paint Finishes

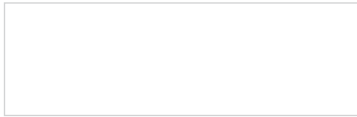

MW matte white



CP champagne



YO yellow 1018

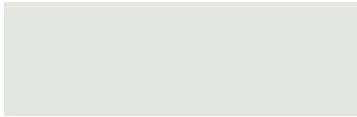

TW textured white

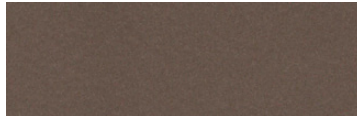

BZ bronze



RD red 3020

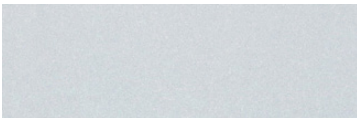

AP anodized paint



BS brass



BU blue 5017

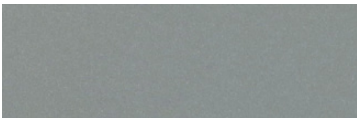

SS satin silver

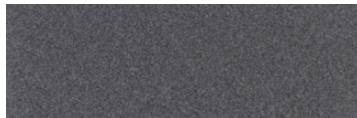

GM gun metal



OR orange 2011

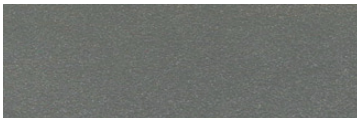

TG textured gray



BR brick red



MN mint 6019

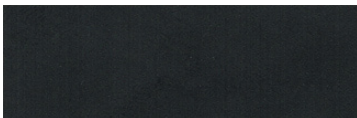

FB flat black



BN brown 8023



GR green 6018

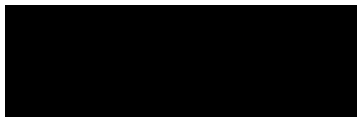

SB satin black



MB military blue



PL purple 4005

For accurate color verification, actual finish samples are available upon request.

Premium Finishes*



BA brushed aluminum



RAL#

*Available on select series. Consult product submittal for availability.

