

job name:
 type:

circ.us™ spec sheet

material

housing

precision CNC spun .063" aluminum. rolled bottom edge for added strength.

diffuser

.125" virgin matte white acrylic panels, with clear spacer disc.

optics

reflector

segmented. .050 aluminum painted high reflectance powder coat matte white.

lamp lens

.125" P95 frost acrylic lens.

LED

custom LED board in 3000K, 3500K, or 4000K (80+ cri standard) optional 90cri (see below). under normal operating conditions, the LEDs employed are rated for >50,000hrs L70 (6.8K) per IES TM-21 from LM-80 test data. white power cord is standard with other color options listed below.

driver

integral, programmable, UL class P, class 2, universal input (120-277v), constant current, 0-10v dimming, 1% minimum dimming level, PF >.9, THD <20%, protections include open and short circuit, overload and over temperature.

mounting

5"dia. spun steel canopy in satin white. four point vertical suspension of 12 ft long stainless steel cables attach to trim with field adjustable grippers that allow for exact AFF mounting heights. optional quadpod to single point cable suspension, with sloped ceiling adapter.

emergency

recommend use of inverter (by other).



catalog number

--	--	--	--

size

- P6726**
(2ft) 26.75"dia X 9"ht
- P6738**
(3ft) 38.75"dia X 11"ht
- P6748**
(4ft) 48.75"dia X 13"ht

LED array

- 30LO** 3000K
- 30HI** 3000K
- 35LO** 3500K
- 35HI** 3500K
- 40LO** 4000K
- 40HI** 4000K
- CL** xxxx lm
custom lumens
consult factory

painted finish

- AP** anodized paint
- BS** brass
- BU** blue
- BZ** bronze
- CP** champagne
- FB** flat black
- GM** gun metal
- MB** military blue
- MW** matte white
- OR** orange
- RD** red
- SB** satin black
- SS** satin silver
- TG** textured gray
- YO** yellow

options

- 90CRI**
- QPD** Quadpod hanging system
- BKPC** Black power cord and canopy
- SBPC** Silver braid power cord and white canopy

premium finish

RAL specify RAL#

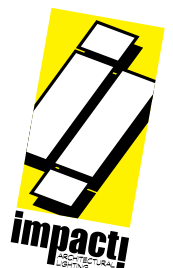

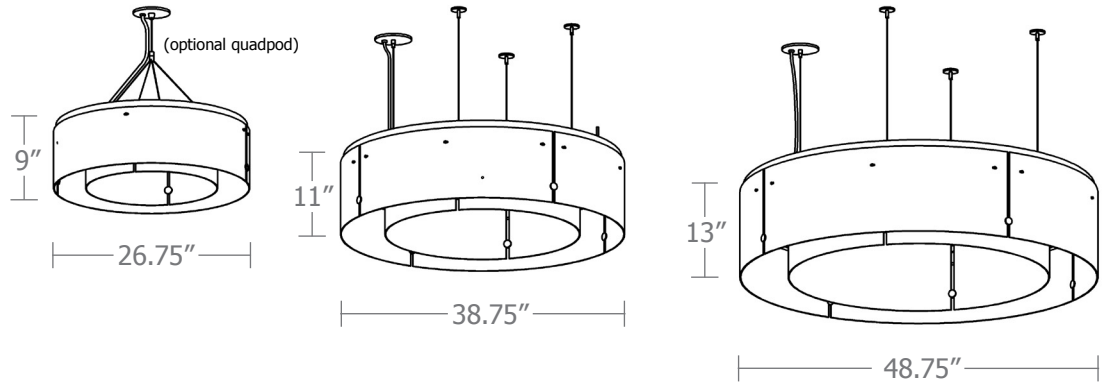

Cat No	Delivered Lumens	Watts		Amps	
		120V / 277V	120V	277V	277V
P6726 LO	2809	30	0.25	0.11	
P6726 HI	5461	55.8	0.47	0.20	
P6738 LO	3414	37	0.31	0.13	
P6738 HI	6827	73	.61	0.26	
P6748 LO	5300	59	.49	.21	
P6748 HI	9300	104	.87	.38	

*delivered lumens based on 4000K, 80+ cri
(90cri multiplier .83)

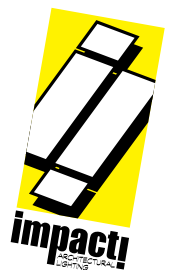

Powder Coat Paint Finishes

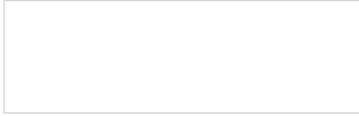

MW matte white

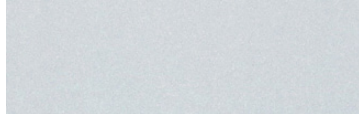

AP anodized paint

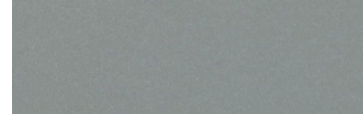

SS satin silver



TG textured gray

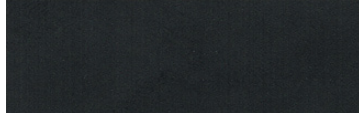

FB flat black

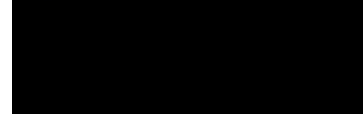

SB satin black



CP champagne

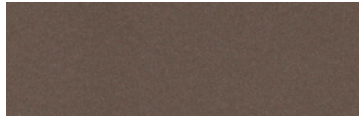

BZ bronze



GM gun metal



OR orange 2011



BU blue 5017



BS brass



RD red 3020



YO yellow 1018



MB military blue

For accurate color verification, actual finish samples are available upon request.

Premium Finishes*



RAL#

*Available on select series. Consult product submittal for availability.

