

job name:   
 type:

## slikk™ spec sheet

### material

#### trim ring

precision CNC spun .063" aluminum. rolled top edge for added strength.

#### diffuser

.125" virgin white acrylic bell-shaped inner lens, provides very diffuse illumination.

### optics

#### reflector

22 gauge aluminum powder coat painted high reflectance matte white.

#### liner

.008" white, 98% high diffuse reflector film increases light output while diffusing LED images.

### LED

custom LED board in 3000K, 3500K, or 4000K (80+ cri standard) optional 90cri (see below).  
 under normal operating conditions, the LEDs employed are rated for >50,000hrs L70 (6.8K) per IES TM-21 from LM-80 test data. white power cord is standard with other color options listed below.

### driver

integral, programmable, UL class P, class 2, universal input (120-277v), constant current, 0-10v dimming, 1% minimum dimming level, PF >.9, THD <20%, protections include open and short circuit, overload and over temperature.

### mounting

5"dia. spun steel canopy in satin white. four point vertical suspension of 12 ft long stainless steel cables attach to trim with field adjustable grippers that allow for exact AFF mounting heights. optional quadpod to single point cable suspension, with sloped ceiling adapter.

### emergency

recommend use of inverter (by other).



## catalog number





### size

**P6224** 24"dia X 8"ht

**P6230** 30"dia X 8"ht

### LED array

**30LO** 3000K

**30HI** 3000K

**35LO** 3500K

**35HI** 3500K

**40LO** 4000K

**40HI** 4000K

**CL** xxxx lm  
 custom lumens  
 consult factory

### finish

**AP** anodized paint

**BN** brown

**BR** brick red

**BS** brass

**BU** blue

**BZ** bronze

**CP** champagne

**FB** flat black

**GM** gun metal

**GR** green

**MB** military blue

**MN** mint

**MW** matte white

**OR** orange

**PL** purple

**RD** red

**SB** satin black

**SS** satin silver

**TG** textured gray

**TW** textured white

**YO** yellow

### options

**90CRI**

**QPD** Quadpod hanging system

**BKPC** Black power cord and canopy

**SBPC** Silver braid power cord  
 and white canopy

### premium finish

**RAL** specify RAL#

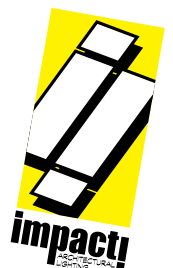

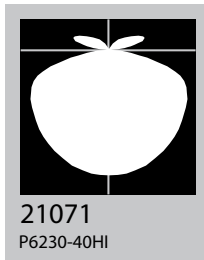
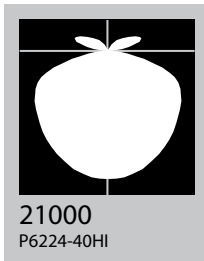
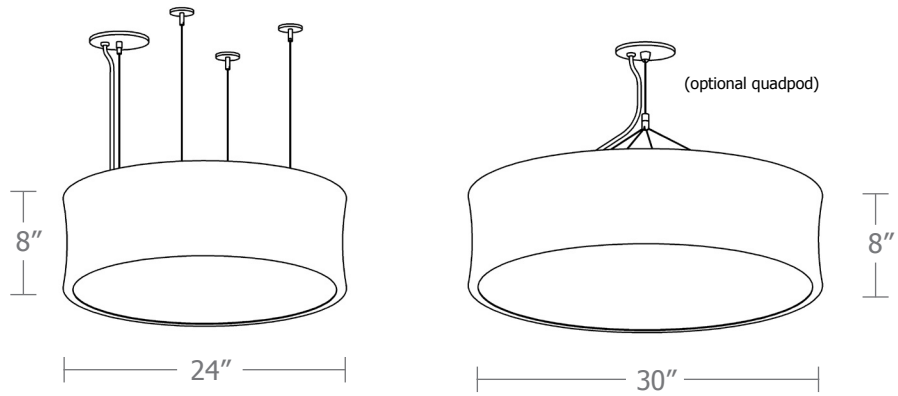

Cat No	Delivered Lumens	Watts		Amps	
		120V / 277V	120V	277V	
<b>P6224 LO</b>	2633	29	0.24	0.10	
<b>P6224 HI</b>	5190	57	0.48	0.19	
		ies file # 21000			
<b>P6230 LO</b>	3950	44	0.37	0.16	
<b>P6230 HI</b>	6759	77	0.64	0.27	
		ies file # 21071			

\*delivered lumens based on 4000K, 80+ cri  
(90cri multiplier .83)

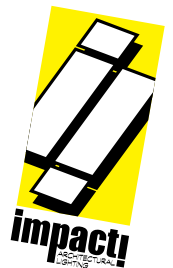

## Powder Coat Paint Finishes

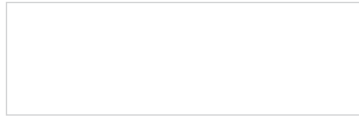

**MW** matte white



**CP** champagne



**YO** yellow 1018

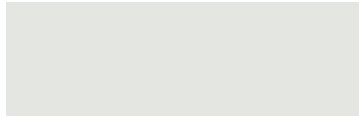

**TW** textured white

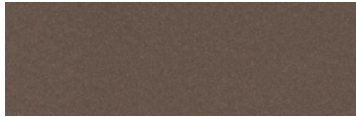

**BZ** bronze



**RD** red 3020

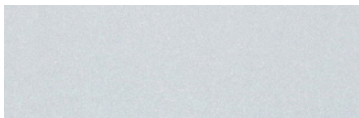

**AP** anodized paint



**BS** brass



**BU** blue 5017

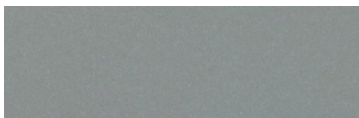

**SS** satin silver

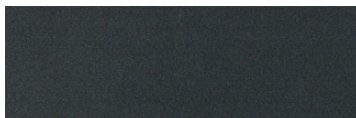

**GM** gun metal



**OR** orange 2011

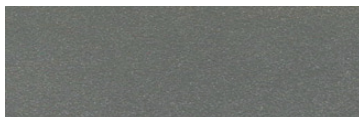

**TG** textured gray



**BR** brick red



**MN** mint 6019

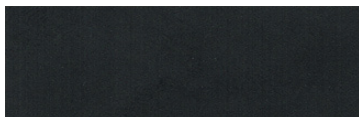

**FB** flat black



**BN** brown 8023



**GR** green 6018

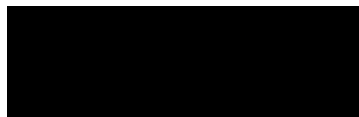

**SB** satin black



**MB** military blue



**PL** purple 4005

For accurate color verification, actual finish samples are available upon request.

## Premium Finishes\*



**RAL#**

\*Available on select series. Consult product submittal for availability.

