

job name:   
 type:

## mere™ spec sheet

### driver housing / power head

extruded aluminum with silver anodized or black anodized finish, acts as heat sink as well. also available in painted finishes listed below.

### diffuser

6" dia. .100" virgin matte white acrylic cylinder.

### bottom lens (optional)

P95 frosted acrylic bottom lens solvent welded to bottom of cylindrical diffuser.

### LED module

COB array in 2700K, 3000K, 3500K, or 4000K. (call factory for 5000K) (80+ cri standard) optional 90cri (see below). under normal operating conditions, the LEDs employed are rated for >50,000hrs L70 (6.8K) per IES TM-21 from LM-80 test data.

### driver

integral, programmable, UL class P, class 2, universal input (120-277v), constant current, 0-10v dimming, 1% minimum dimming level, PF >.9, THD <20%, protections include open and short circuit, overload and over temperature.

### mounting

5" dia. spun steel canopy in satin white with single or dual stainless steel cables and field adjustable grippers that allow for exact AFF mounting heights.

### premium mountings

#### colored cloth cord (optional)

extruded aluminum canopy painted to match fixture. ultrathin vertical stainless steel cable and field adjustable gripper that allow for exact AFF mounting heights. cloth-covered power cord color options listed below. cord requires special stripping tool (link).

#### power over cable (optional)

extruded aluminum canopy painted to match fixture. Class 2 LED powered suspension system that suspends and powers the fixture with thin stainless steel copper-core conductive cables, providing a clean look without the need for a separate power cord. powered suspension requires cable cutter (link) specifically designed to cut stainless steel aircraft cable from 1/32" to 1/8".

### emergency

recommend use of inverter (by other). optional WREM: wired for remote EM battery (by other). if using WHPC, SBPC, or BKPC cords, 2nd power cord required.

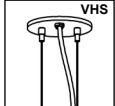

## catalog number

size	CCT	lumens	powerhead finish	power cord	options
<b>P2519</b> 6" dia X 19"ht	<b>27</b> 2700K	<b>FX</b> 1660 lm	<b>AN</b> silver anodized	<b>WHPC</b> white power cord and canopy	<b>3FT</b> 36" cable
	<b>30</b> 3000K	<b>LO</b> 2300 lm	<b>ANB</b> anodized black	<b>BKPC</b> black power cord and canopy	<b>6FT</b> 72" cable
	<b>35</b> 3500K	<b>HI</b> 3200 lm	<b>painting finish</b>	<b>SBPC</b> silver braid power cord and white canopy	<b>12FT</b> 144" cable*
<b>P2528</b> 6" dia X 28"ht	<b>40</b> 4000K	<b>HX</b> 4100 lm	<b>BN</b> brown	<b>premium</b> (driver canopy required) (not available w/ 12ft option)	<b>90CRI</b>
		<b>CL*</b> xxxx lm <small>* custom lumens consult factory</small>	<b>BR</b> brick red	<b>BUPC</b> blue cloth cord	<b>BL</b> frosted acrylic bottom lens, solvent welded.
			<b>BS</b> brass	<b>ORPC</b> orange cloth cord	<b>VHS</b> 2-point vertical hanging system
			<b>BU</b> blue	<b>PLPC</b> purple cloth cord	<b>WREM</b> wired for remote EM battery pack (by other) (see note above)
			<b>BZ</b> bronze	<b>RDPC</b> red cloth cord	<small>*not available with premium power cords</small>
			<b>CP</b> champagne	<b>WGPC</b> white & gray dot cloth cord	
			<b>GM</b> gun metal	<b>POC</b> power over cable	
			<b>GR</b> green		
			<b>MB</b> military blue		
			<b>MN</b> mint		
			<b>MW</b> matte white		
			<b>OR</b> orange		
			<b>PL</b> purple		
			<b>RD</b> red		
			<b>SS</b> satin silver		
			<b>TG</b> textured gray		
			<b>TW</b> textured white		
			<b>YO</b> yellow		

### premium finish

**RAL** specify RAL#

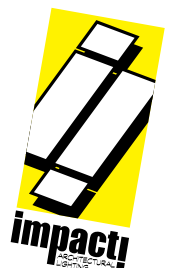

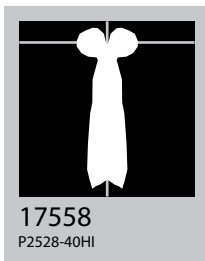
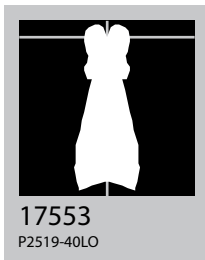
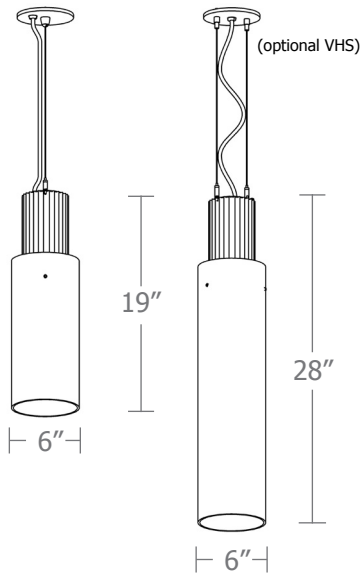

Cat No	Delivered Lumens*	Watts		Amps	
		120V / 277V	120V	277V	
<b>P2519 FX</b>	1660	14	.12	.05	
<b>P2519 LO</b>	2300	20	.17	.07	
		ies file # 17553			
<b>P2519 HI</b>	3200	29	.24	.10	
<b>P2519 HX</b>	4100	38	.32	.14	
<b>P2528 FX</b>	1660	14	.12	.05	
<b>P2528 LO</b>	2300	20	.17	.07	
<b>P2528 HI</b>	3200	29	.24	.10	
		ies file # 17558			
<b>P2528 HX</b>	4100	38	.32	.14	

\*delivered lumens based on 4000K, 80+ cri (90cri multiplier .83)  
BL multiplier .90

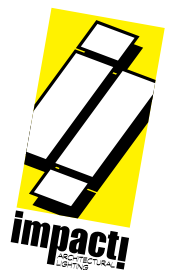

## Powder Coat Paint Finishes

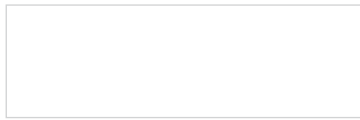

**MW** matte white



**CP** champagne



**YO** yellow 1018

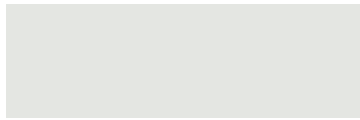

**TW** textured white

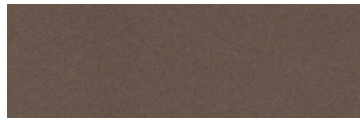

**BZ** bronze



**RD** red 3020



**BS** brass



**BU** blue 5017

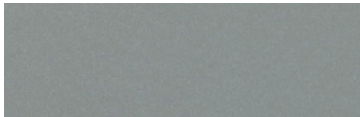

**SS** satin silver

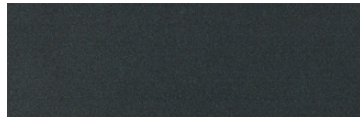

**GM** gun metal



**OR** orange 2011

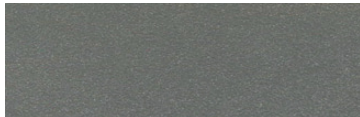

**TG** textured gray



**BR** brick red



**MN** mint 6019



**BN** brown 8023



**GR** green 6018



**MB** military blue



**PL** purple 4005

For accurate color verification, actual finish samples are available upon request.

## Premium Finishes\*



**RAL#**

\*Available on select series. Consult product submittal for availability.

