

job name:   
 type:

## na.row.r™ ceiling spec sheet 90CRI

### material

2"dia smooth extruded aluminum outer housing in six lengths.

### LED

COB in 2700K, 3000K, 3500K, or 4000K 90+ cri standard rated >36,000 hours L70 (6.8K) per LM-80 test data, and 71,000 hours projected life per IES TM-21.

### downlight optics

Khatod® Cosmo 50mm dia 16mm high (RoHS compliant) available in 12° spot, 25° medium, 38° wide

### driver

constant current, class P, class 2 power unit, class A sound rating, universal input (120-277V) programmable driver, 5% minimum dimming level, PF >0.90. protections include short circuit, input/output isolation and surge protection (3KV). wired for 0-10v dimming from factory.

### mounting

#### standard

driver in junction box (requires 2 1/8" deep electrical box). 5" dia canopy painted to match fixture. satin black canopy standard on wood finishes.

#### remote enclosure (.LV) (optional)

the standard driver can be remote mounted up to 33ft from the LED. suspension length should be considered in distance. remote enclosure supplied. for distances greater than 33ft consult factory. for Chicago Plenum installation consult factory.

### finish

select from 15 standard powder coat paint finishes or 3 wood finishes (listed below) or specify RAL# for custom colors.

### emergency

if required, recommend use of inverter (by other).



## catalog number

--	--	--	--	--

### size

**C3906** driver in j-box  
**C3906.LV** remote enclosure  
 2"dia X 6.25"ht

**C3912** driver in j-box  
**C3912.LV** remote enclosure  
 2"dia X 12.25"ht

**C3918** driver in j-box  
**C3918.LV** remote enclosure  
 2"dia X 18.25"ht

**C3924** driver in j-box  
**C3924.LV** remote enclosure  
 2"dia X 24.25"ht

**C3936\*** driver in j-box  
**C3936.LV\*** remote enclosure  
 2"dia X 36.25"ht

**C3948\*** driver in j-box  
**C3948.LV\*** remote enclosure  
 2"dia X 48.25"ht

\*extended lead time

### beam

**S** 12° spot  
**M** 25° med  
**W** 38° wide

### CCT

**27** 2700K  
**30** 3000K  
**35** 3500K  
**40** 4000K

### lumens

**L1** 360 lm  
**L2** 630 lm  
**L3** 900 lm  
**H1** 1265 lm  
**H2** 1805 lm

### painted finish

**AP** anodized paint  
**BS** brass  
**BU** blue  
**BZ** bronze  
**CP** champagne  
**FB** flat black  
**GM** gun metal  
**MB** military blue  
**MW** matte white  
**OR** orange  
**RD** red  
**SB** satin black  
**SS** satin silver  
**TG** textured gray  
**YO** yellow

### premium finish

**RAL** specify RAL#

### wood finish

**ASH** ashwood  
**ENG** english brown oak  
**ESP** espresso



remote enclosure



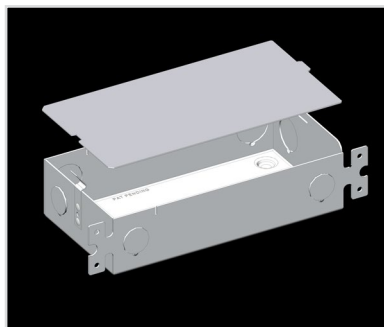
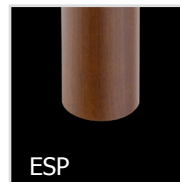
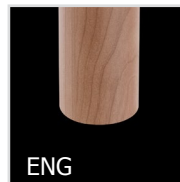
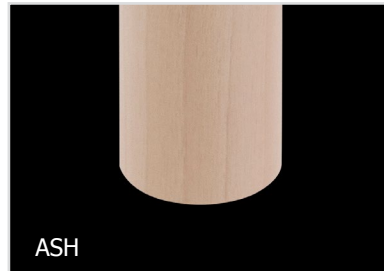
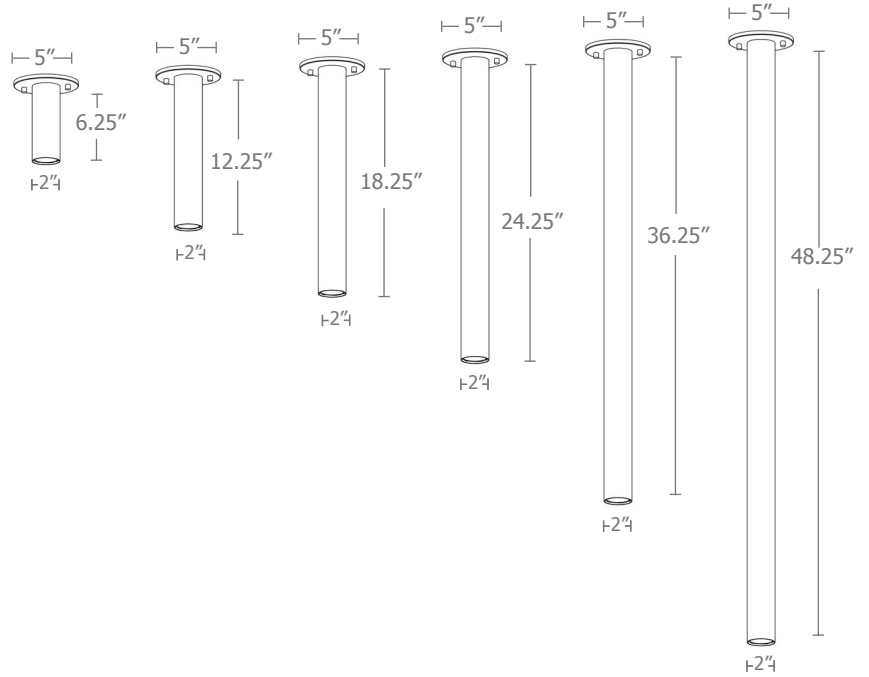
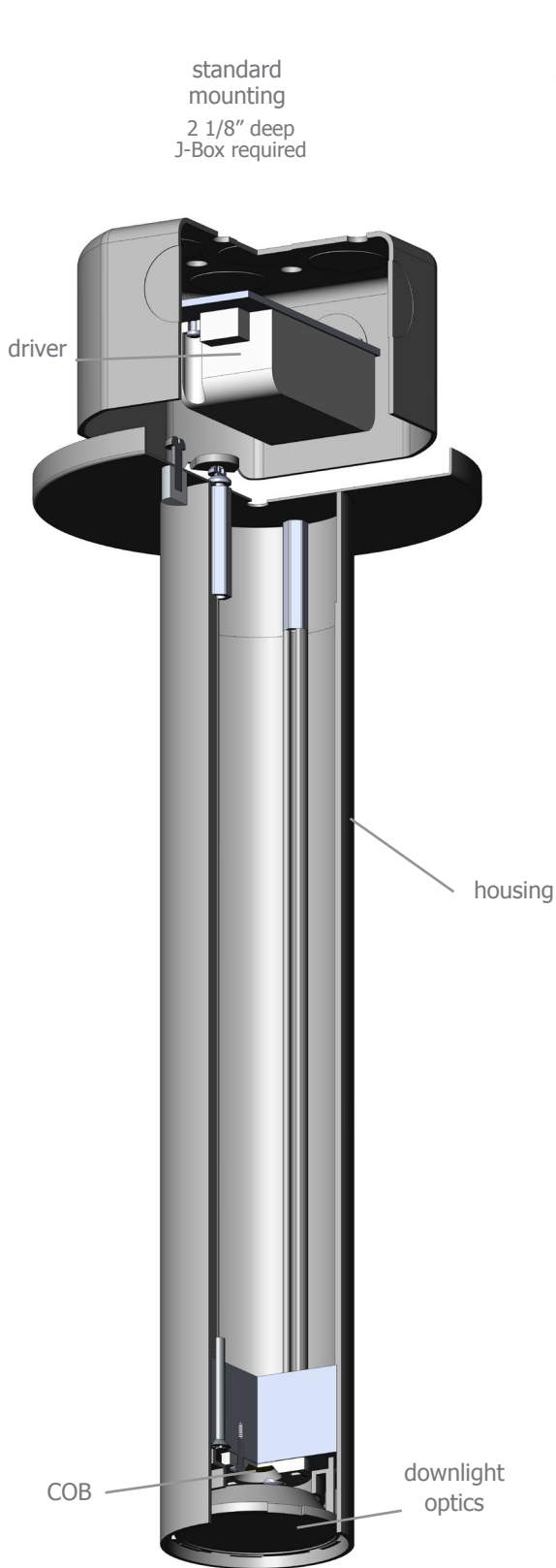

# Calculation Table

Consult factory for applications assistance



Cat No	Delivered* Lumens	Watts 120V / 277V	IES File #	LLF to be applied
<b>L1</b>	360	3	<b>07222C</b> spot	.30
			<b>07222B</b> med	.30
			<b>07222A</b> wide	.30
<b>L2</b>	630	6	<b>07222C</b> spot	.53
			<b>07222B</b> med	.53
			<b>07222A</b> wide	.53
<b>L3</b>	900	9	<b>07222C</b> spot	.76
			<b>07222B</b> med	.76
			<b>07222A</b> wide	.76
<b>H1</b>	1265	13	<b>07222C</b> spot	1.07
			<b>07222B</b> med	1.07
			<b>07222A</b> wide	1.07
<b>H2</b>	1805	19	<b>07222C</b> spot	1.52
			<b>07222B</b> med	1.52
			<b>07222A</b> wide	1.52

\*delivered lumens based on 4000K, 90+ cri

The application of a Light Loss Factor is required to:

- match the lumen output for the power module specified
- incorporate the increased lumen output due to LED/Driver upgrades

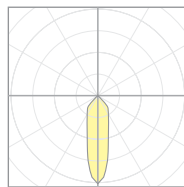

**07222C**  
P39xx-S-40H1  
S 12° spot

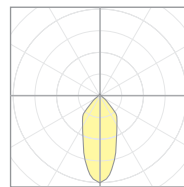

**07222B**  
P39xx-M-40H1  
M 25° med

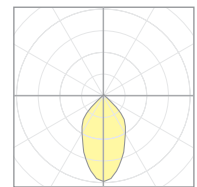

**07222A**  
P39xx-W-40H1  
W 38° wide

## Powder Coat Paint Finishes

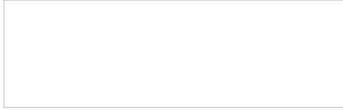

**MW** matte white

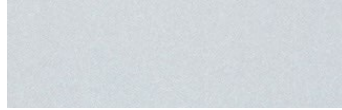

**AP** anodized paint



**SS** satin silver



**TG** textured gray

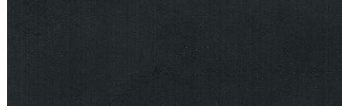

**FB** flat black



**SB** satin black

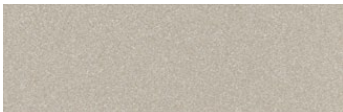

**CP** champagne

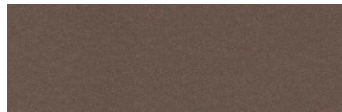

**BZ** bronze

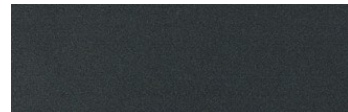

**GM** gun metal



**OR** orange 2011



**BU** blue 5017



**BS** brass



**RD** red 3020



**YO** yellow 1018



**MB** military blue

## Premium Finishes\*

### Wood Finishes

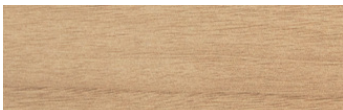

**ASH** ashwood

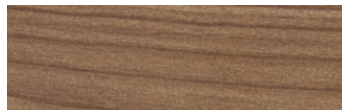

**ENG** english brown oak



**ESP** espresso

For accurate color verification, actual finish samples are available upon request.



**RAL#**

\*Available on select series. Consult product submittal for availability.

