

job name:   
 type:

## sq.3™ ceiling spec sheet 90CRI

### housing

3.5" smooth square extruded architectural 6063 aluminum outer housing in four lengths available in 15 standard powder coat paint finishes listed below. premium RAL and wood finishes also available.

### LED

COB in 2700K, 3000K, 3500K, or 4000K (90 cri standard) rated >36,000 hours L70 (6.8K) per LM-80 test data, and 71,000 hours projected life per IES TM-21.

### downlight optics

LEDiL® Angelina 82mm dia 31mm high (RoHS compliant) available in 20° spot, 30° medium, 50° wide with specular anodized finish. 90° extra wide features matte white highly reflective finish. color mixing sublens standard. standard mounting clamp allows for easy replacement of reflector in field. the typical total beam angle is the full angle measured where the luminous intensity is half of the peak volume.

### driver

integral\*, constant current, class P, class 2 power unit, class A sound rating, universal input (120-277V) programmable driver, 5% minimum dimming level, PF >0.90. protections include short circuit, input/output isolation and surge protection (3KV). wired for 0-10v dimming from factory. 6" canopy painted to match fixture. satin black canopy standard on wood finishes.

### finish

select from 15 standard powder coat paint finishes or 3 wood finishes (listed below) or specify RAL# for custom colors.

### emergency

if required, recommend use of inverter (by other).



## catalog number

size	beam	CCT	lumens	painting finish
<b>C6606</b> 3.5"sq X 6.25"ht	<b>S</b> 20° spot	<b>27</b> 2700K	<b>L1</b> 395 lm	<b>AP</b> anodized paint
<b>C6612</b> 3.5"sq X 12.25"ht	<b>M</b> 30° med	<b>30</b> 3000K	<b>L2</b> 695 lm	<b>BS</b> brass
<b>C6618</b> 3.5"sq X 18.25"ht	<b>W</b> 50° wide	<b>35</b> 3500K	<b>L3</b> 995 lm	<b>BU</b> blue
<b>C6624</b> 3.5"sq X 24.25"ht	<b>XW</b> 90° extra wide	<b>40</b> 4000K	<b>H1</b> 1390 lm	<b>BZ</b> bronze
			<b>H2</b> 1985 lm	<b>CP</b> champagne
			<b>H3*</b> 2780 lm	<b>FB</b> flat black
			<small>*H3 lumen package in C6606 requires min. 2-1/8" deep j-box.</small>	<b>GM</b> gun metal
				<b>MB</b> military blue
				<b>MW</b> matte white
				<b>OR</b> orange
				<b>RD</b> red
				<b>SB</b> satin black
				<b>SS</b> satin silver
				<b>TG</b> textured gray
				<b>YO</b> yellow
				<b>premium finish</b>
				<b>RAL</b> specify RAL#
				<b>wood finish</b>
				<b>ASH</b> ashwood
				<b>ENG</b> english brown oak
				<b>ESP</b> espresso



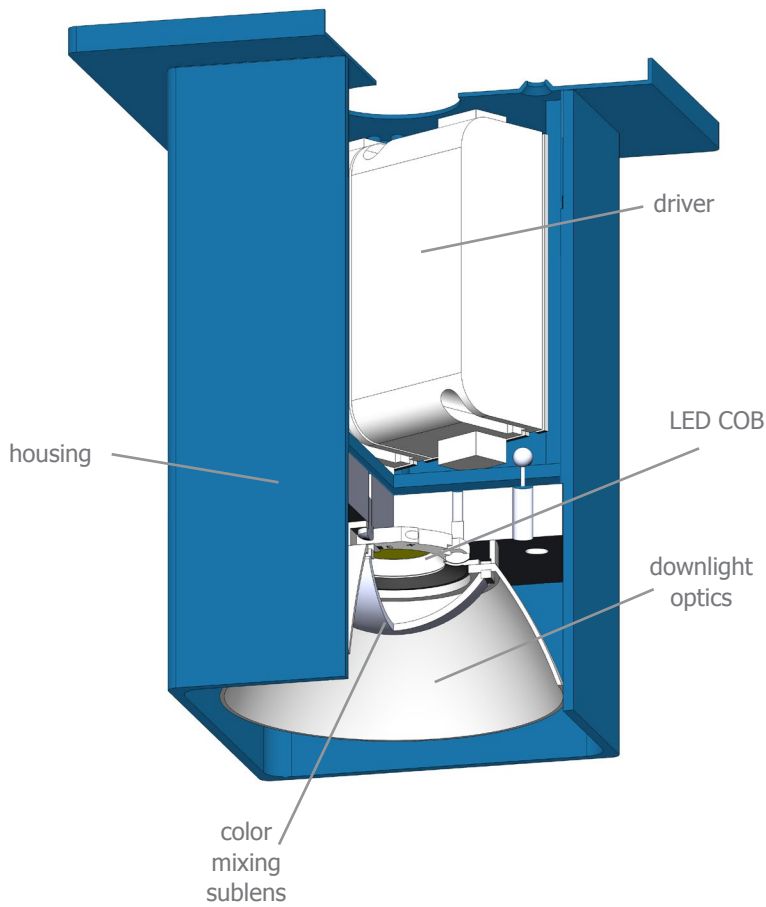
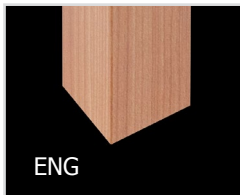
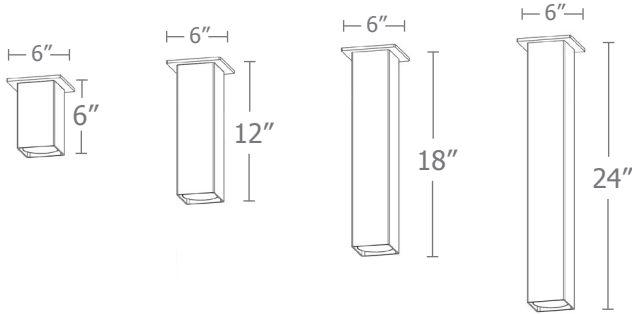

# Calculation Table

The application of a Light Loss Factor is required to:

- match the lumen output for the power module specified
- incorporate the increased lumen output due to LED/Driver upgrades

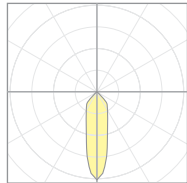

**20921**  
P7506-S-40H3  
S 20° spot

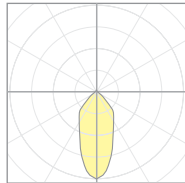

**20922**  
P7506-M-40H3  
M 30° med

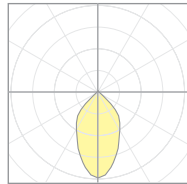

**20923**  
P7506-W-40H3  
W 50° wide

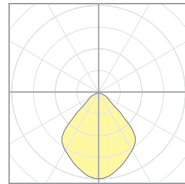

**20924**  
P7506-EW-40H3  
XW 90° extra wide

Cat No	Delivered* Lumens	Watts 120V / 277V	IES File #**	LLF to be applied
<b>L1</b>	395	4	<b>W 20923</b>	.12
<b>L2</b>	695	7	<b>W 20923</b>	.22
<b>L3</b>	995	10	<b>W 20923</b>	.31
<b>H1</b>	1390	14	<b>W 20923</b>	.44
<b>H2</b>	1985	20	<b>W 20923</b>	.63
<b>H3</b>	2780	28	<b>W 20923</b>	.88
	S 20° spot	M 30° med	W 50° wide	XW 90° extra
ies file #	20921	20922	20923	20924

\*delivered lumens based on 4000K, 90+ cri \*\*choose the file that matches your beam spread

## Typical Lighting Layout

Schedule						
Symbol	Quantity	Manufacturer	Catalog Number	Description	Lamp	Wattage
	1	Impact Architectural Lighting	C6612 W 40 H1	12" length sq.3 ceiling mount downlight cylinder	4000k 90cri LED	21

Statistics						
Description	Symbol	Avg	Max	Min	Max/Min	Avg/Min
sq.3	+	26.9 fc	47.6 fc	20.3 fc	2.3:1	1.3:1

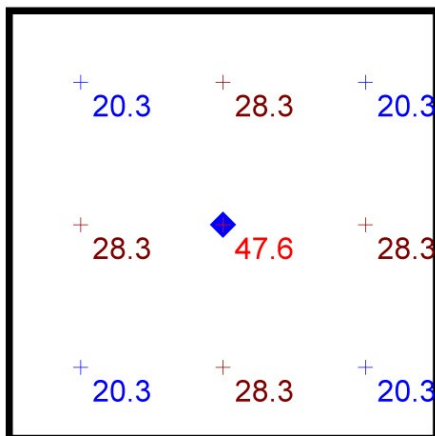

**Plan View**  
Scale - 1" = 2ft

- 10' x 10' space
- 80/50/20 reflectances
- bottom of fixture at 10' aff
- FC readings at 2.5' aff
- layout conducted using H2 lumen output 1985 lumens unit w/ 50-deg. beam spread



## Powder Coat Paint Finishes

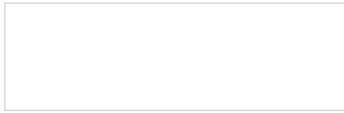

**MW** matte white



**AP** anodized paint



**SS** satin silver



**TG** textured gray

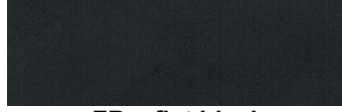

**FB** flat black

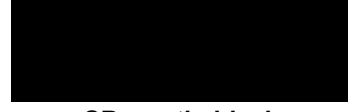

**SB** satin black



**CP** champagne

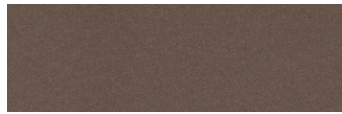

**BZ** bronze



**GM** gun metal



**OR** orange 2011



**BU** blue 5017



**BS** brass



**RD** red 3020



**YO** yellow 1018



**MB** military blue

## Premium Finishes\*

### Wood Finishes

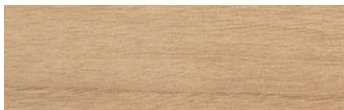

**ASH** ashwood

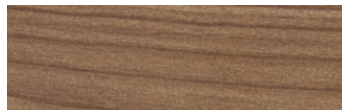

**ENG** english brown oak



**ESP** espresso

For accurate color verification, actual finish samples are available upon request.



**RAL#**

\*Available on select series. Consult product submittal for availability.

