

job name:
 type:

sq.3™ ceiling spec sheet 90CRI

housing

3.5" smooth square extruded architectural 6063 aluminum outer housing in four lengths available in 15 standard powder coat paint finishes listed below.

LED

COB in 2700K, 3000K, 3500K, or 4000K (90 cri standard) rated >36,000 hours L70 (6.8K) per LM-80 test data, and 71,000 hours projected life per IES TM-21.

downlight optics

LEDiL® Angelina 82mm dia 31mm high (RoHS compliant) available in 20° spot, 30° medium, 50° wide with specular anodized finish. 90° extra wide features matte white highly reflective finish. color mixing sublens standard. standard mounting clamp allows for easy replacement of reflector in field. the typical total beam angle is the full angle measured where the luminous intensity is half of the peak volume.

driver

in canopy, constant current, class P, class 2 power unit, class A sound rating, universal input (120-277V) programmable driver, 5% minimum dimming level, PF >0.90. protections include short circuit, input/output isolation and surge protection (3KV). wired for 0-10v dimming from factory.

finish

select from 15 standard powder coat paint finishes listed below or specify RAL# for custom colors.

emergency

if required, recommend use of inverter (by other).



catalog number

size	beam	CCT	lumens	painting finish
C6606 3.5"dia X 6"ht	S 20° spot M 30° med W 50° wide	27 2700K 30 3000K 35 3500K 40 4000K	L1 395 lm L2 695 lm L3 995 lm H1 1390 lm H2 1985 lm H3 2780 lm	AP anodized paint BS brass BU blue BZ bronze CP champagne FB flat black GM gun metal MB military blue MW matte white OR orange RD red SB satin black SS satin silver TG textured gray YO yellow
C6612 3.5"dia X 12"ht	XW 90° extra wide			
C6618 3.5"dia X 18"ht				
C6624 3.5"dia X 24"ht				
				premium finish RAL specify RAL#

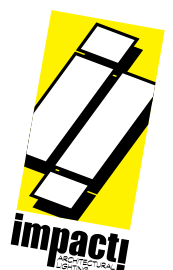

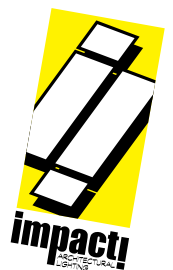
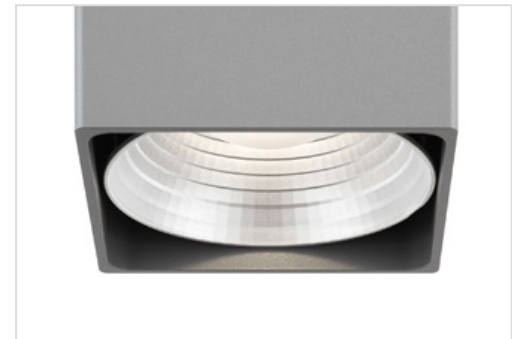
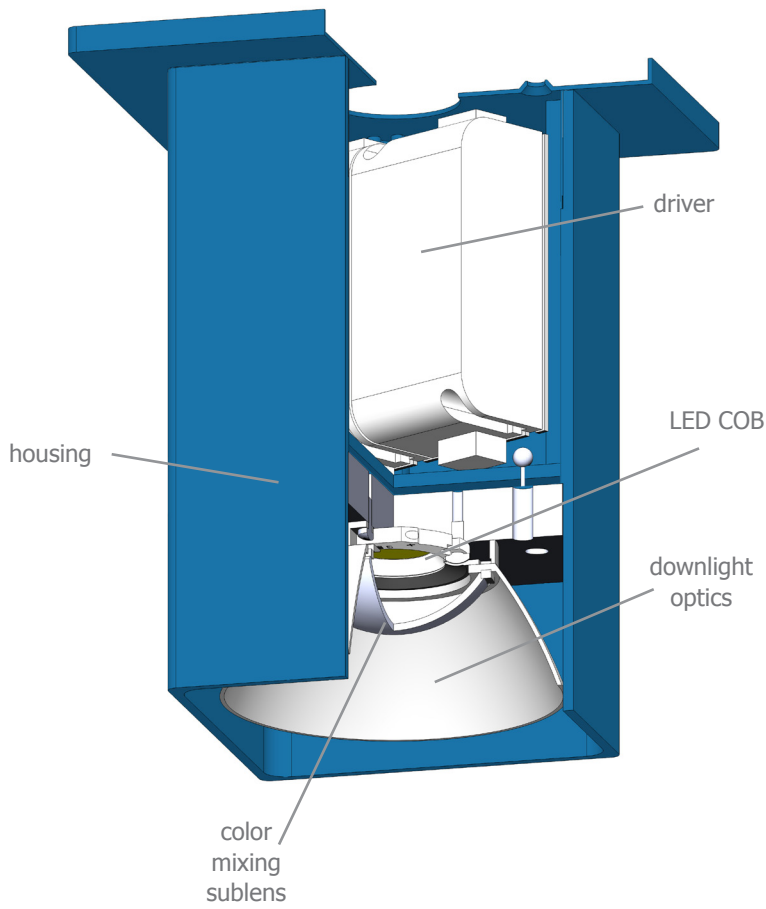
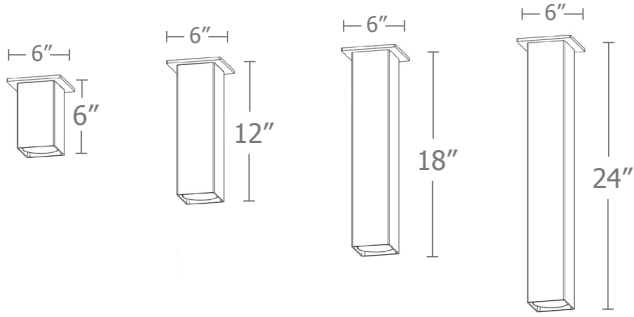

Calculation Table

The application of a Light Loss Factor is required to:

- match the lumen output for the power module specified
- incorporate the increased lumen output due to LED/Driver upgrades

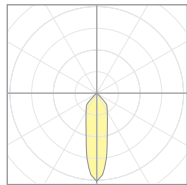

20921
P7506-S-40H3
S 20° spot

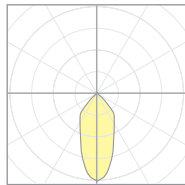

20922
P7506-M-40H3
M 30° med

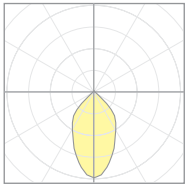

20923
P7506-W-40H3
W 50° wide

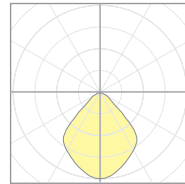

20924
P7506-EW-40H3
XW 90° extra wide

Cat No	Delivered* Lumens	Watts 120V / 277V	IES File #**	LLF to be applied
L1	395	4	W 20923	.12
L2	695	7	W 20923	.22
L3	995	10	W 20923	.31
H1	1390	14	W 20923	.44
H2	1985	20	W 20923	.63
H3	2780	28	W 20923	.88
	S 20° spot	M 30° med	W 50° wide	XW 90° extra
ies file #	20921	20922	20923	20924

*delivered lumens based on 4000K, 90+ cri

**choose the file that matches your beam spread

Typical Lighting Layout

Schedule						
Symbol	Quantity	Manufacturer	Catalog Number	Description	Lamp	Wattage
	1	Impact Architectural Lighting	C6612 W 40 H1	12" length sq.3 ceiling mount downlight cylinder	4000k 90cri LED	21

Statistics						
Description	Symbol	Avg	Max	Min	Max/Min	Avg/Min
sq.3	+	26.9 fc	47.6 fc	20.3 fc	2.3:1	1.3:1

- 10' x 10' space
- 80/50/20 reflectances
- bottom of fixture at 10' aff
- FC readings at 2.5' aff
- layout conducted using H2 lumen output 1985 lumens unit w/ 50-deg. beam spread

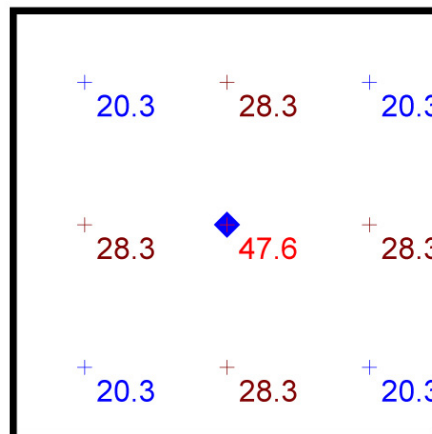

Plan View
Scale - 1" = 2ft

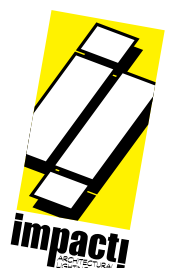

Powder Coat Paint Finishes

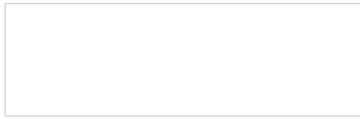

MW matte white



AP anodized paint



SS satin silver



TG textured gray



FB flat black



SB satin black



CP champagne

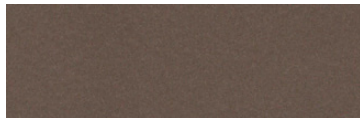

BZ bronze



GM gun metal



OR orange 2011



BU blue 5017



BS brass



RD red 3020



YO yellow 1018



MB military blue

For accurate color verification, actual finish samples are available upon request.

Premium Finishes*



RAL#

*Available on select series. Consult product submittal for availability.

