

job name:
 type:

sq.3.up™ spec sheet 90CRI direct/indirect

material

3.5" smooth square extruded architectural 6063 aluminum outer housing in four lengths available in 15 standard powder coat paint finishes listed below. premium RAL and wood finishes also available.

LED

COBs in 2700K, 3000K, 3500K, or 4000K (90+ cri standard) rated >36,000 hours L70 (6.8K) per LM-80 test data, and 71,000 hours projected life per IES TM-21.

downlight optics

LEDiL® Angelina 82mm dia 31mm high (RoHS compliant) available in 20° spot, 30° medium, 50° wide with specular anodized finish. 90° extra wide features matte white highly reflective finish. color mixing sublens standard. standard mounting clamp allows for easy replacement of reflector in field. the typical total beam angle is the full angle measured where the luminous intensity is half of the peak volume.

uplight diffuser

.118" thick laser cut optimum light diffusion acrylic. 72% light transmission with matte surface providing light scattering glare reduction. Colorless diffusion significantly reducing color shift of the LED's.

drivers

constant current, class P, class 2 power units, class A sound rating, universal input (120-277V) programmable driver, 5% minimum dimming level, PF >0.90. protections include short circuit, input/output isolation and surge protection (3KV). wired for 0-10v dimming from factory.

mounting

standard

driver in matching extruded aluminum driver canopy painted to match fixture. ultrathin vertical stainless steel cables and field adjustable grippers that allow for exact AFF mounting heights. silver braid power cord standard. special universal mounting bracket allows EC to clock fixture orientation during installation. 5" canopy painted to match fixture. satin black canopy standard on wood finishes.

remote enclosure (.LV) (optional)

the standard driver can be remote mounted up to 33ft from the LED. suspension length should be considered in distance. remote enclosure supplied. for distances greater than 33ft consult factory. for Chicago Plenum installation consult factory.

finish

select from 15 standard powder coat paint finishes or 3 wood finishes (listed below) or specify RAL# for custom colors.

emergency

if required, recommend use of inverter (by other).

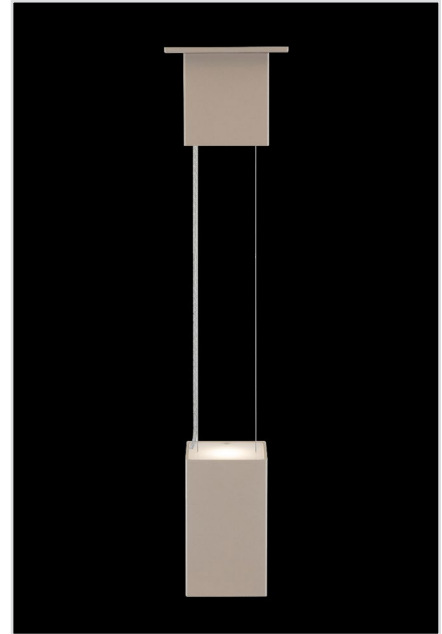

catalog number

direct

indirect

size	downlight beam spread	CCT	downlight lumens	uplight lumens	painted finish	options
P7606.up		27 2700K	L1 395 lm	L1 340 lm	AP anodized paint	3FT 36" cables
P7606.up.LV <small>remote enclosure</small> 3.5" dia X 6" ht	S 20° spot	30 3000K	L2 695 lm	L2 590 lm	BS brass	6FT 72" cables
	M 30° med	35 3500K	L3 995 lm	L3 845 lm	BU blue	
	W 50° wide	40 4000K	H1 1390 lm		BZ bronze	
	XW 90° extra wide		H2 1985 lm		CP champagne	
					FB flat black	
P7612.up			L1 395 lm	L1 340 lm	GM gun metal	
P7612.up.LV <small>remote enclosure</small> 3.5" dia X 12" ht			L2 695 lm	L2 590 lm	MB military blue	
			L3 995 lm	L3 845 lm	MW matte white	
P7618.up			H1 1390 lm	H1 1185 lm	OR orange	
P7618.up.LV <small>remote enclosure</small> 3.5" dia X 18" ht			H2 1985 lm		RD red	
			H3 2780 lm		SB satin black	
P7624.up					SS satin silver	
P7624.up.LV <small>remote enclosure</small> 3.5" dia X 24" ht					TG textured gray	
					YO yellow	
					premium finish	
					RAL specify RAL#	
					wood finish	
					ASH ashwood	
					ENG english brown oak	
					ESP espresso	



remote enclosure



www.impactltg.com / 314-427-1212 / saint louis, mo



specifications subject to change © 2025 rev. 04/22/2025

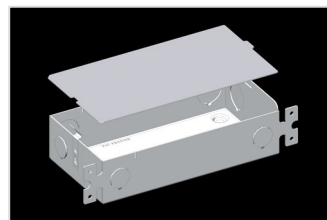
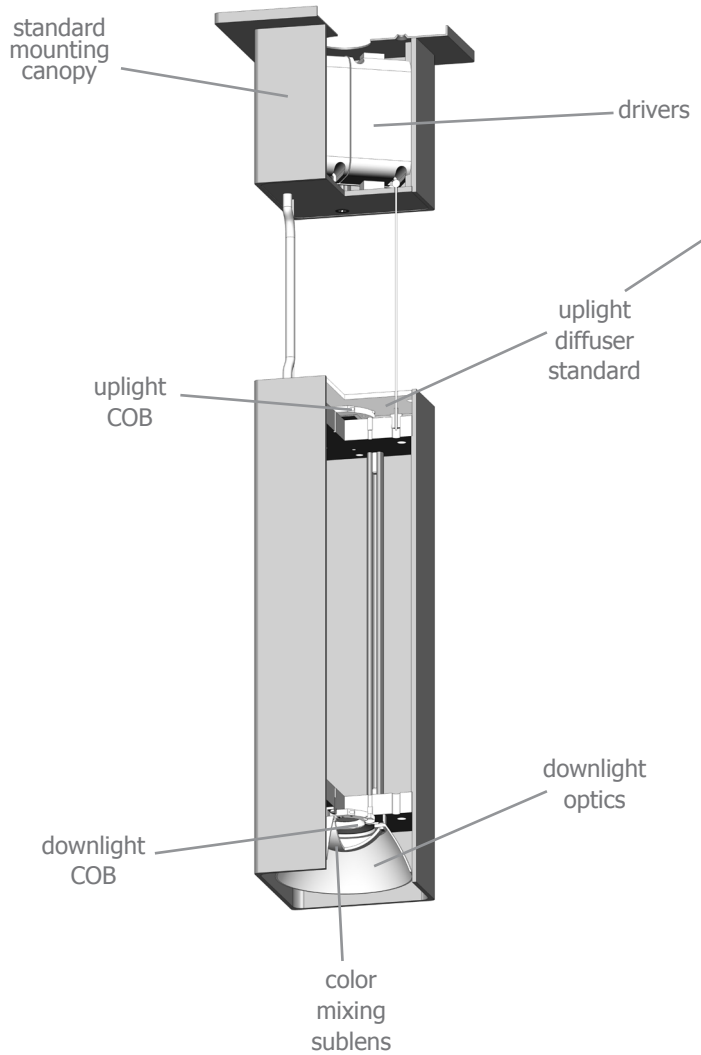
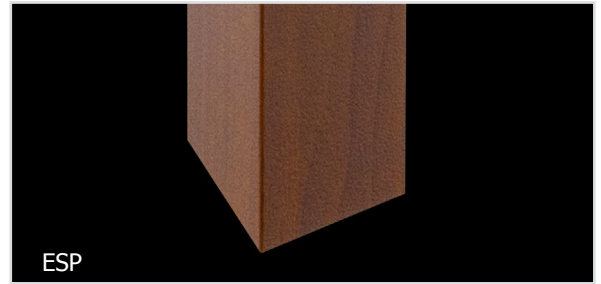
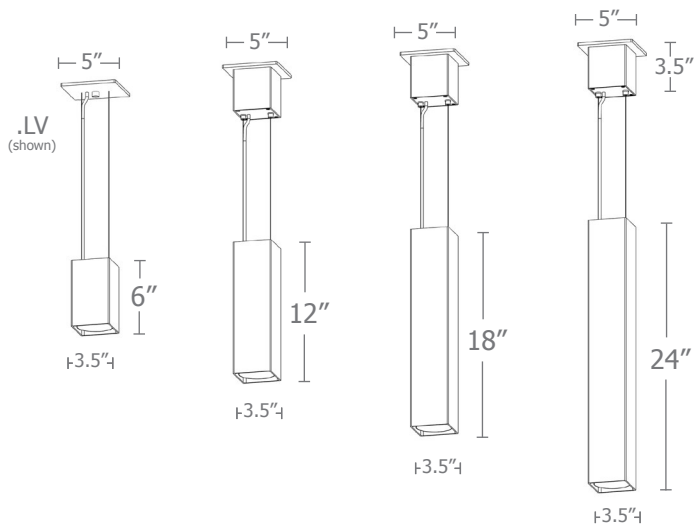

Quick Calc Typical Lighting Layout

- 8' x 8' x 10'H space
- 80/50/20 reflectances
- bottom of fixture at 8' aff
- FC readings at 2.5' aff
- layout conducted with P6606.up H2 1985 lumen 90 CRI downlight and L3 845 lumen uplight

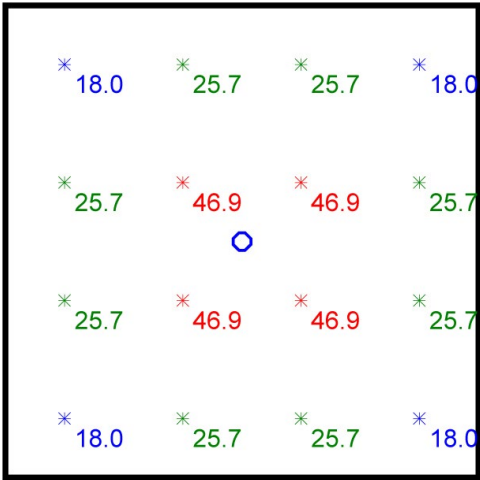

Plan View
Scale - 1" = 2ft

Statistics						
Description	Symbol	Avg	Max	Min	Max/Min	Avg/Min
sq.3.up	+	29.1 fc	46.9 fc	18.0 fc	2.6:1	1.6:1

Schedule							
Symbol	QTY	Manufacturer	Catalog Number	Description	Lamp	Wattage	
	1	Impact Architectural Lighting	P6606.up M 40 H2 L3	3.5"dia. x 6"h sq.3.up luminaire	4000k 90cri LED	30	

Advanced Calculation Typical Lighting Layout

uses separate files to give designer ultimate flexibility and accuracy

- 8' x 8' x 12'H space
- 80/50/20 reflectances
- bottom of fixture at 9' aff
- FC readings at 2.5' aff
- layout conducted using P6606.up with H2 1985 lumen 90 CRI downlight package and L3 845 lumen uplight

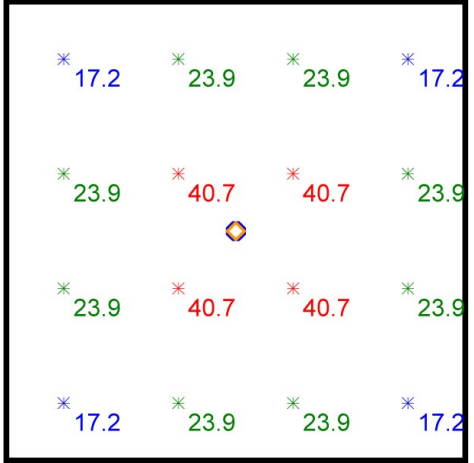

Plan View
Scale - 1" = 2ft

Schedule							
Symbol	QTY	Manufacturer	Catalog Number	Description	Lamp	Wattage	
	1	Impact Architectural Lighting	P6606 W 40 H2 xx down only	3.5"dia. x 6"h sq.3.up luminaire DOWNLIGHT ONLY	4000k 90cri LED	21	
	1	Impact Architectural Lighting	P6606 x 40xx L3 uplight only	UPLIGHT ONLY	4000k 90cri LED	10	

Statistics						
Description	Symbol	Avg	Max	Min	Max/Min	Avg/Min
sq.3.up	+	26.4 fc	40.7 fc	17.2 fc	2.4:1	1.5:1



Quick Calc Table

Tests indicated below are a combination of direct and indirect. LLFs are as close as possible. Downlight is given priority.

for more detailed calculations see table on next page.

Cat No	Direct Delivered* Lumens	Indirect Delivered* Lumens	Watts 120V / 277V	IES File #	LLF to be applied
P6606 L1 L1	395	340	8	12201	.16
P6606 L2 L2	695	590	14	12201	.28
P6606 L3 L3	995	845	20	12201	.40
P6606 H1 L3	1390	845	24	12201	.56
P6606 H2 L3	1985	845	31	12201	.79
**					
P66XX L1 L1	395	340	8	12203	.11
P66XX L2 L2	695	590	14	12203	.20
P66XX L3 L3	995	845	20	12203	.29
P66XX H1 H1	1390	845	28	12203	.40
P66XX H2 H1	1985	845	35	12203	.57
P66XX H3 H1	2780	1185	42	12203	.80

*delivered lumens based on 4000K, 90+ cri
 **XX = 12", 18", or 24" length

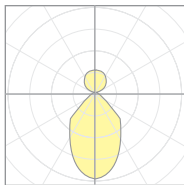

12201
 P7606-40HX-UP/DN

The application of a Light Loss Factor is required to:

- match the lumen output for the power module specified
- incorporate the increased lumen output due to LED/Driver upgrades



Advanced Calculation Table

Tests are for each element separately and must be "stacked" to represent single fixture
 Consult factory for applications assistance

Direct

Indirect

Cat No	Delivered* Lumens	Watts 120V / 277V	IES File #	LLF to be applied	Delivered* Lumens	Watts 120V / 277V	IES File #	LLF to be applied
L1	395	4	20921 spot	.12	340	4	12202	.24
			20922 med	.12				
			20923 wide	.12				
			20924 x-wide	.12				
L2	695	7	20921 spot	.22	590	7	12202	.42
			20922 med	.22				
			20923 wide	.22				
			20924 x-wide	.22				
L3	995	10	20921 spot	.31	845	10	12202	.60
			20922 med	.31				
			20923 wide	.31				
			20924 x-wide	.31				
H1	1390	14	20921 spot	.43	1185	14	12202	.84
			20922 med	.43				
			20923 wide	.43				
			20924 x-wide	.43				
H2	1985	21	20921 spot	.62				
			20922 med	.62				
			20923 wide	.62				
			20924 x-wide	.62				
H3	2780	28	20921 spot	.86				
			20922 med	.86				
			20923 wide	.86				
			20924 x-wide	.86				

*delivered lumens based on 4000K, 90+ cri

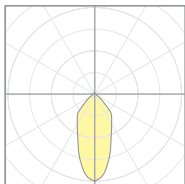

20922
P7506-M-40H3
M 30° med

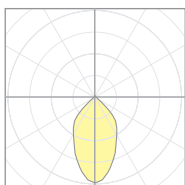

20923
P7506-W-40H3
W 50° wide

The application of a Light Loss Factor is required to:

- match the lumen output for the power module specified
- incorporate the increased lumen output due to LED/Driver upgrades

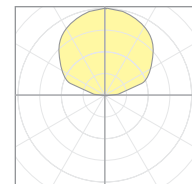

12202
P7606-XXXX-UP



Powder Coat Paint Finishes

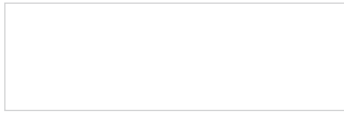

MW matte white



AP anodized paint



SS satin silver



TG textured gray

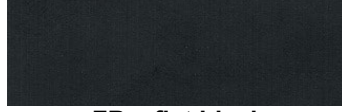

FB flat black

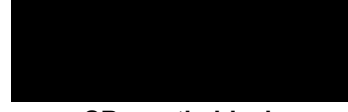

SB satin black



CP champagne

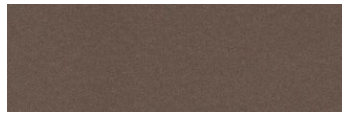

BZ bronze



GM gun metal



OR orange 2011



BU blue 5017



BS brass



RD red 3020



YO yellow 1018



MB military blue

Premium Finishes*

Wood Finishes

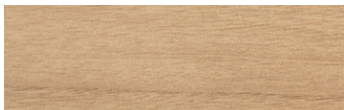

ASH ashwood

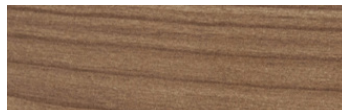

ENG english brown oak

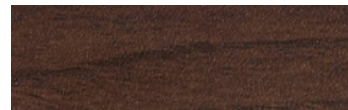

ESP espresso

For accurate color verification, actual finish samples are available upon request.



RAL#

*Available on select series. Consult product submittal for availability.

