

sq.3™ spec sheet 90CRI

housing

3.5" smooth square extruded architectural 6063 aluminum outer housing in four lengths available in 15 standard powder coat paint finishes listed below. premium RAL and wood finishes also available.

LED

COB in 2700K, 3000K, 3500K, or 4000K (90 cri standard) rated >36,000 hours L70 (6.8K) per LM-80 test data, and 71,000 hours projected life per IES TM-21.

downlight optics

LEDiL® Angelina 82mm dia 31mm high (RoHS compliant) available in 20° spot, 30° medium, 50° wide with specular anodized finish. 90° extra wide features matte white highly reflective finish. color mixing sublens standard. standard mounting clamp allows for easy replacement of reflector in field. the typical total beam angle is the full angle measured where the luminous intensity is half of the peak volume.

driver

constant current, class P, class 2 power unit, class A sound rating, universal input (120-277V) programmable driver, 5% minimum dimming level, PF >0.90. protections include short circuit, input/output isolation and surge protection (3KV). wired for 0-10v dimming from factory.

mounting

standard

driver in junction box (requires 2 1/8" deep electrical box). ultrathin vertical stainless steel cables and field adjustable grippers that allow for exact AFF mounting heights. cloth-covered power cord color options listed below. cloth cord requires special stripping tool (link). special universal mounting bracket allows EC to clock fixture orientation during installation. 5" sq. canopy painted to match fixture. satin black canopy standard on wood finishes.

canopy mounted driver (CDVR) (optional)

5" sq. canopy with 3.5" x 3.5" extruded square, painted to match fixture (see image below). satin black canopy standard on wood finishes.

remote enclosure (.LV) (optional)

the standard driver can be remote mounted up to 33ft from the LED. suspension length should be considered in distance. remote enclosure supplied. for distances greater than 33ft consult factory. for Chicago Plenum installation consult factory.

power over cable (POC) (optional)

Class 2 LED powered suspension system that suspends and powers the fixture with thin stainless steel copper-core conductive cables, providing a clean look without the need for a separate power cord. powered suspension requires cable cutter (link) specifically designed to cut stainless steel aircraft cable from 1/32" to 1/8". 5"sq canopy painted to match fixture. satin black canopy standard on wood finishes.

finish

select from 15 standard powder coat paint finishes or 3 wood finishes (listed below) or specify RAL# for custom colors.

emergency

if required, recommend use of inverter (by other).

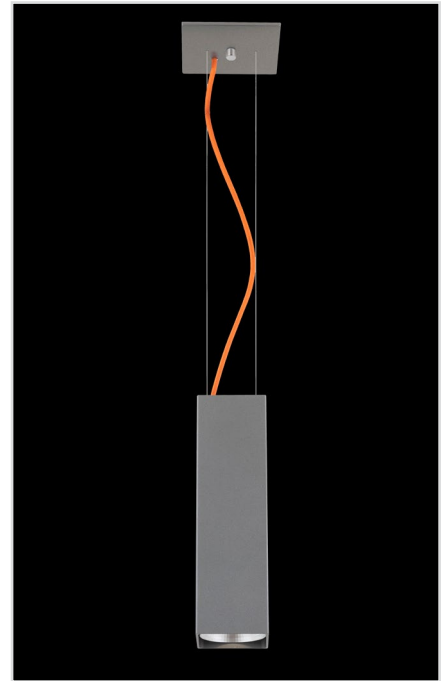

catalog number

--	--	--	--	--	--	--

size	beam	CCT	lumens	painting finish	power cord	options
P6606 driver in j-box	S 20° spot	27 2700K	L1 395 lm	AP anodized paint	BUPC blue cloth cord	3FT 36" cables
P6606.LV remote enclosure 3.5"dia X 6"ht	M 30° med	30 3000K	L2 695 lm	BS brass	ORPC orange cloth cord	6FT 72" cables
	W 50° wide		L3 995 lm	BU blue	PLPC purple cloth cord	CDVR canopy mounted driver
	XW 90° extra wide	35 3500K		BZ bronze	RDPC red cloth cord	
P6612 driver in j-box		40 4000K	H1 1390 lm	CP champagne	WGPC white & gray dot cloth cord	
P6612.LV remote enclosure 3.5"dia X 12"ht			H2 1985 lm	FB flat black		
			H3 2780 lm	GM gun metal	POC power over cable	
P6618 driver in j-box				MB military blue		
P6618.LV remote enclosure 3.5"dia X 18"ht				MW matte white	WHPC white cord	
				OR orange	BKPC black cord	
P6624 driver in j-box				RD red	SBPC silver braid cord	
P6624.LV remote enclosure 3.5"dia X 24"ht				SB satin black		
				SS satin silver		
				TG textured gray		
				YO yellow		
				premium finish		
				RAL specify RAL#		
				wood finish		
				ASH ashwood		
				ENG english brown oak		
				ESP espresso		

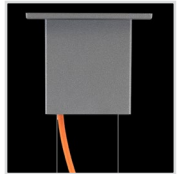

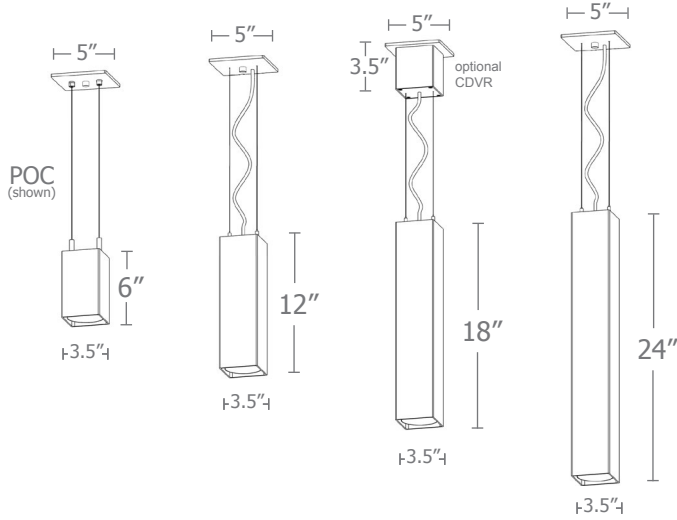

standard mounting
2 1/8" deep
J-Box required

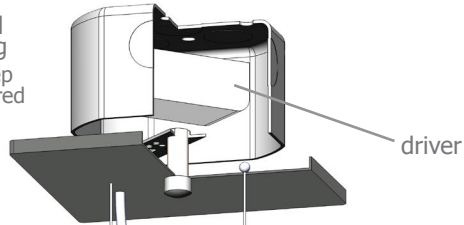

driver

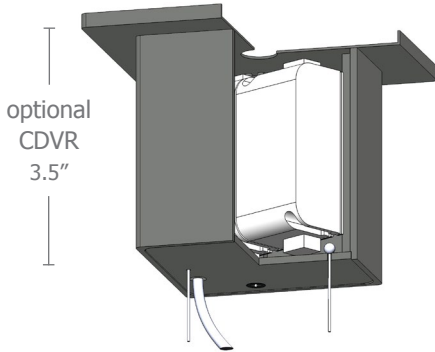

optional CDVR
3.5"

housing

COB

downlight optics

color mixing
sublens



ESP

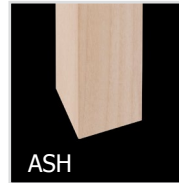

ASH

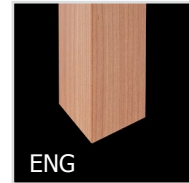

ENG

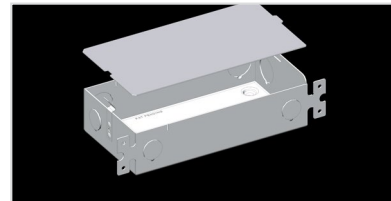

Calculation Table

The application of a Light Loss Factor is required to:

- match the lumen output for the power module specified
- incorporate the increased lumen output due to LED/Driver upgrades

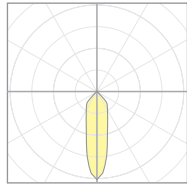

20921
P7506-S-40H3
S 20° spot

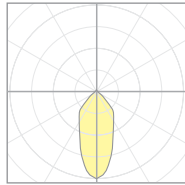

20922
P7506-M-40H3
M 30° med

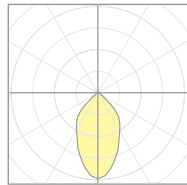

20923
P7506-W-40H3
W 50° wide

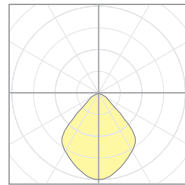

20924
P7506-EW-40H3
XW 90° extra wide

Cat No	Delivered* Lumens	Watts 120V / 277V	IES File #**	LLF to be applied
L1	395	4	W 20923	.15
L2	695	7	W 20923	.26
L3	995	10	W 20923	.37
H1	1390	14	W 20923	.52
H2	1985	20	W 20923	.75
H3	2780	28	W 20923	1.04
	S 20° spot	M 30° med	W 50° wide	XW 90° extra
ies file #	20921	20922	20923	20924

*delivered lumens based on 4000K, 90+ cri **choose the file that matches your beam spread

Typical Lighting Layout

Schedule						
Symbol	Quantity	Manufacturer	Catalog Number	Description	Lamp	Wattage
	1	Impact Architectural Lighting	P7512 W 40 H2	12" length sq.3 downlight cylinder	4000k 90cri LED	21

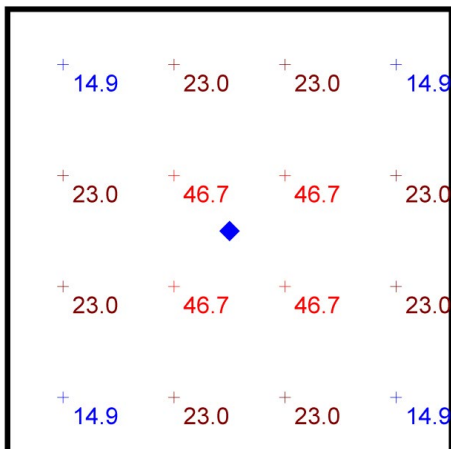

Plan View
Scale - 1" = 2ft

Statistics						
Description	Symbol	Avg	Max	Min	Max/Min	Avg/Min
sq.3	+	26.9 fc	46.7 fc	14.9 fc	3.1:1	1.8:1

- 10' x 10' x 14'H space
- 80/50/20 reflectances
- bottom of fixture at 10' aff
- FC readings at 2.5' aff
- layout conducted using H2 lumen output 1985 lumens unit w/ 50-deg. beam spread



Powder Coat Paint Finishes

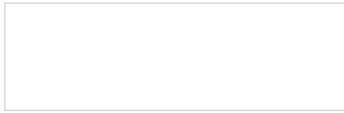

MW matte white



AP anodized paint



SS satin silver



TG textured gray

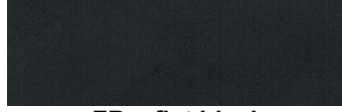

FB flat black

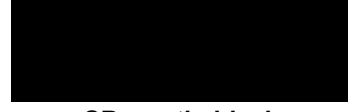

SB satin black



CP champagne

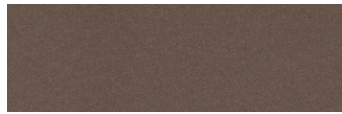

BZ bronze



GM gun metal



OR orange 2011



BU blue 5017



BS brass



RD red 3020



YO yellow 1018



MB military blue

Premium Finishes*

Wood Finishes

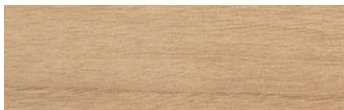

ASH ashwood

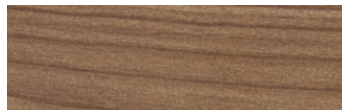

ENG english brown oak



ESP espresso

For accurate color verification, actual finish samples are available upon request.



RAL#

*Available on select series. Consult product submittal for availability.

