

job name:
 type:

fl.air™ spec sheet

material

housing

precision CNC spun .064" aluminum outer housing available in 21 standard powder coat paint finishes listed below.

diffuser

.125" Satinice WD855 light scattering, glare reduction acrylic. Colorless diffusion reduces CCT shift. 72% high light transmission.

LED

custom LED board in 3000K, 3500K, or 4000K (80+ cri standard) optional 90cri (see below). LEDs are rated >50,000 hours L70 (10K) at 85°C per LM-80 test data, and 70,000 hours projected life per IES TM-21. power cord color options listed below.

driver

in canopy, constant current, class P, class 2 power unit, class A sound rating, universal input (120-277V) programmable driver, 1% minimum dimming level, PF >0.90. protections include short circuit, input/output isolation and surge protection (3KV). wired for 0-10v dimming.

mounting

spun aluminum canopy painted to match fixture. three ultrathin vertical stainless steel cables and field adjustable grippers that allow for exact AFF mounting heights. cloth-covered power cord color options listed below. cord requires special stripping tool (link).

power over cable (optional)

Class 2 LED powered suspension system that suspends and powers the fixture with thin stainless steel copper-core conductive cables, providing a clean look without the need for a separate power cord. powered suspension requires cable cutter (link) specifically designed to cut stainless steel aircraft cable from 1/32" to 1/8".

finish

select from standard powder coat paint finishes or specify RAL# for custom colors.

emergency

if required, recommend use of inverter (by other).



catalog number

--	--	--	--	--

size

- P5808**
8.5"dia X 3"ht
- P5812**
12.5"dia X 4"ht
- P5816**
16.25"dia X 5.25 "ht

LED

- 30LO** 3000K
30HI 3000K
- 35LO** 3500K
35HI 3500K
- 40LO** 4000K
40HI 4000K

standard finishes

- AP** anodized paint
BN brown
BR brick red
BS brass
BU blue
BZ bronze
CP champagne
FB flat black
GM gun metal
GR green
MB military blue
MN mint
MW matte white
OR orange
PL purple
RD red
SB satin black
SS satin silver
TG textured gray
TW textured white
YO yellow

premium finish

RAL specify RAL#

power cord

- BUPC** blue cloth cord
ORPC orange cloth cord
PLPC purple cloth cord
RDPC red cloth cord
WGPC white & gray dot cloth cord
POC power over cable

options

- 3FT** 36" cables
6FT 72" cables
90CRI

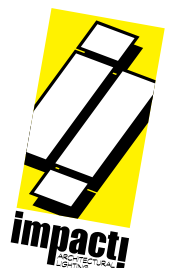

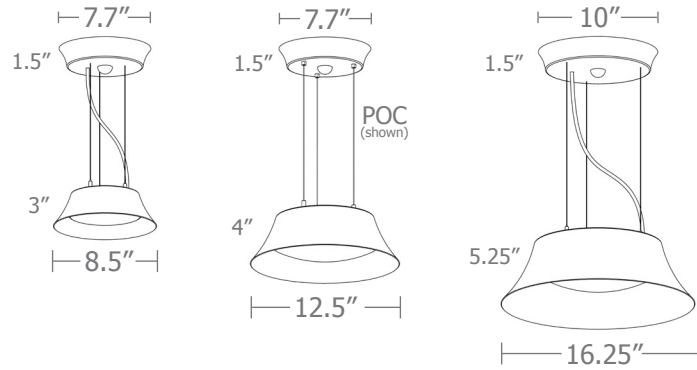

Cat No	Delivered* Lumens	Watts		Amps	
		120V / 277V	120V	277V	277V
P5808 LO	1015	11	.09	.04	
P5808 HI	2000	21	.18	.08	
P5812 LO	1515	17	.14	.06	
P5812 HI	3030	32	.27	.12	
P5816 LO	2000	22	.18	.08	
P5816 HI	4000	42	.35	.15	

* delivered lumens based on 4000K, 80+ cri (90cri multiplier .83)

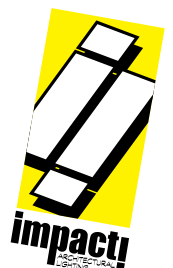
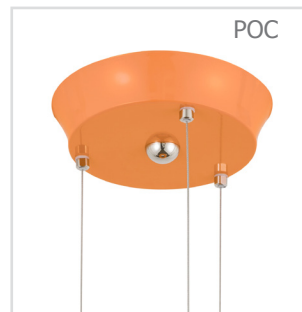

Powder Coat Paint Finishes

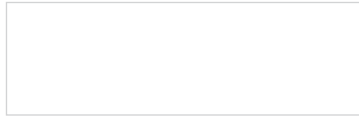

MW matte white



CP champagne



YO yellow 1018

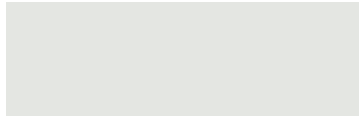

TW textured white

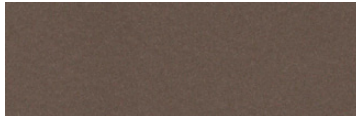

BZ bronze



RD red 3020



AP anodized paint



BS brass



BU blue 5017

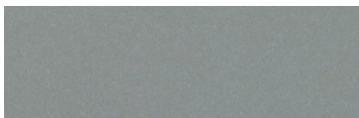

SS satin silver

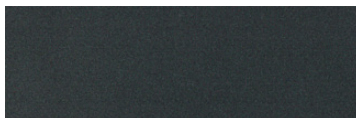

GM gun metal



OR orange 2011

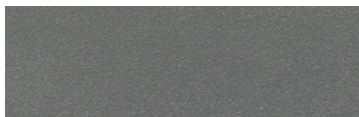

TG textured gray



BR brick red



MN mint 6019

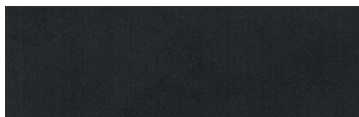

FB flat black



BN brown 8023



GR green 6018

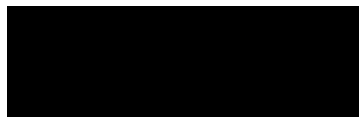

SB satin black



MB military blue



PL purple 4005

For accurate color verification, actual finish samples are available upon request.

Premium Finishes*



RAL#

*Available on select series. Consult product submittal for availability.

