

**na.row™ spec sheet 90CRI direct**

**material**

3.5" dia. smooth extruded aluminum outer housing in four lengths available in 15 standard powder coat paint finishes listed below. premium RAL and wood finishes also available.

**LED**

COB in 2700K, 3000K, 3500K, or 4000K 90 cri standard rated >36,000 hours L70 (6.8K) per LM-80 test data, and 71,000 hours projected life per IES TM-21.

**downlight optics**

LEDiL® Angelina 82mm dia 31mm high (RoHS compliant) available in 20° spot, 30° medium, 50° wide with specular anodized finish. 90° extra wide features matte white highly reflective finish. color mixing sublens standard. standard mounting clamp allows for easy replacement of reflector in field. the typical total beam angle is the full angle measured where the luminous intensity is half of the peak volume.

**driver**

constant current, class P, class 2 power unit, class A sound rating, universal input (120-277V) programmable driver, 5% minimum dimming level, PF >0.90. protections include short circuit, input/output isolation and surge protection (3KV). wired for 0-10v dimming from factory.

**mounting**

**standard**

driver in junction box (requires 2 1/8" deep electrical box). ultrathin vertical stainless steel cable and field adjustable gripper that allow for exact AFF mounting heights. cloth-covered power cord color options listed below. cloth cord requires special stripping tool (link). 5" dia canopy painted to match fixture. satin black canopy standard on wood finishes.

**canopy mounted driver (CDVR)** (optional)

5" dia canopy with 3.5" x 3.5" extruded aluminum painted to match fixture (see image below)

**remote enclosure (.LV)** (optional)

the standard driver can be remote mounted up to 33ft from the LED. suspension length should be considered in distance. remote enclosure supplied. for distances greater than 33ft consult factory. for Chicago Plenum installation consult factory.

**power over cable (POC)** (optional)

Class 2 LED powered suspension system that suspends and powers the fixture with thin stainless steel copper-core conductive cables, providing a clean look without the need for a separate power cord. powered suspension requires cable cutter (link) specifically designed to cut stainless steel aircraft cable from 1/32" to 1/8".

**finish**

select from 15 standard powder coat paint finishes or 3 wood finishes (listed below) or specify RAL# for custom colors.

**emergency**

if required, recommend use of inverter (by other).



**catalog number**

--	--	--	--	--	--	--

size	beam	CCT	lumens	painting finish	power cord	options
<b>P7606</b> driver in j-box	<b>S</b> 20° spot	<b>27</b> 2700K	<b>L1</b> 395 lm	<b>AP</b> anodized paint	<b>BUPC</b> blue cloth cord	<b>3FT</b> 36" cables
<b>P7606.LV</b> remote enclosure 3.5" dia X 6" ht	<b>M</b> 30° med	<b>30</b> 3000K	<b>L2</b> 695 lm	<b>BS</b> brass	<b>ORPC</b> orange cloth cord	<b>6FT</b> 72" cables
<b>P7612</b> driver in j-box	<b>W</b> 50° wide	<b>35</b> 3500K	<b>L3</b> 995 lm	<b>BU</b> blue	<b>PLPC</b> purple cloth cord	<b>CDVR</b> canopy mounted driver
<b>P7612.LV</b> remote enclosure 3.5" dia X 12" ht	<b>XW</b> 90° extra wide	<b>40</b> 4000K	<b>H1</b> 1390 lm	<b>BZ</b> bronze	<b>RDPC</b> red cloth cord	
<b>P7618</b> driver in j-box			<b>H2</b> 1985 lm	<b>CP</b> champagne	<b>WGPC</b> white & gray dot cloth cord	
<b>P7618.LV</b> remote enclosure 3.5" dia X 18" ht			<b>H3</b> 2780 lm	<b>FB</b> flat black	<b>POC</b> power over cable	
<b>P7624</b> driver in j-box				<b>GM</b> gun metal	<b>WHPC</b> white cord	
<b>P7624.LV</b> remote enclosure 3.5" dia X 24" ht				<b>MB</b> military blue	<b>BKPC</b> black cord	
				<b>MW</b> matte white	<b>SBPC</b> silver braid cord	
				<b>OR</b> orange		
				<b>RD</b> red		
				<b>SB</b> satin black		
				<b>SS</b> satin silver		
				<b>TG</b> textured gray		
				<b>YO</b> yellow		

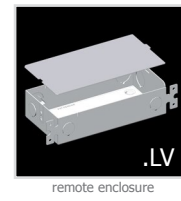

**premium finish**

**RAL** specify RAL#

**wood finish**

- ASH** ashwood
- ENG** english brown oak
- ESP** espresso



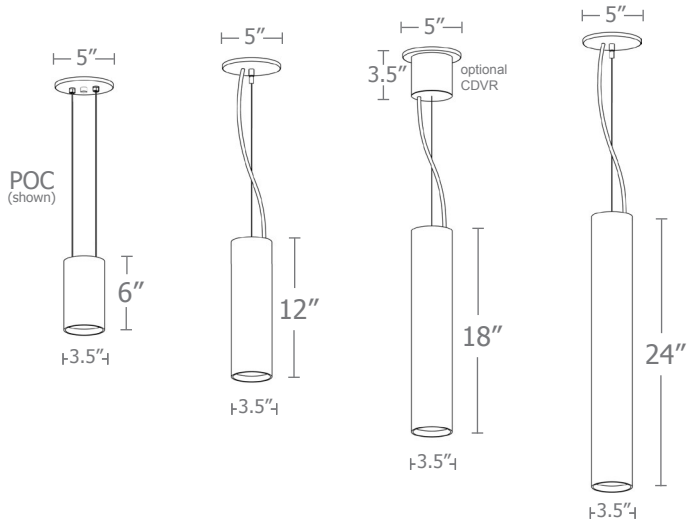

standard mounting  
2 1/8" deep  
J-Box required

driver

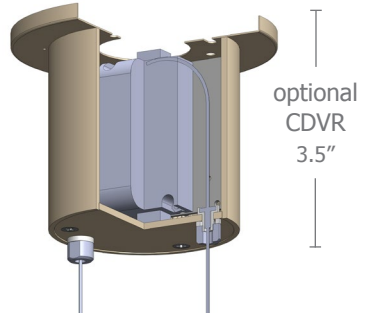
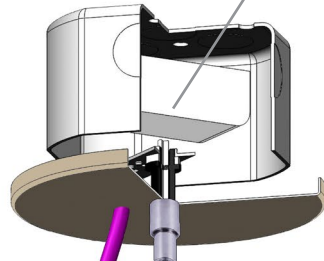

optional  
CDVR  
3.5"

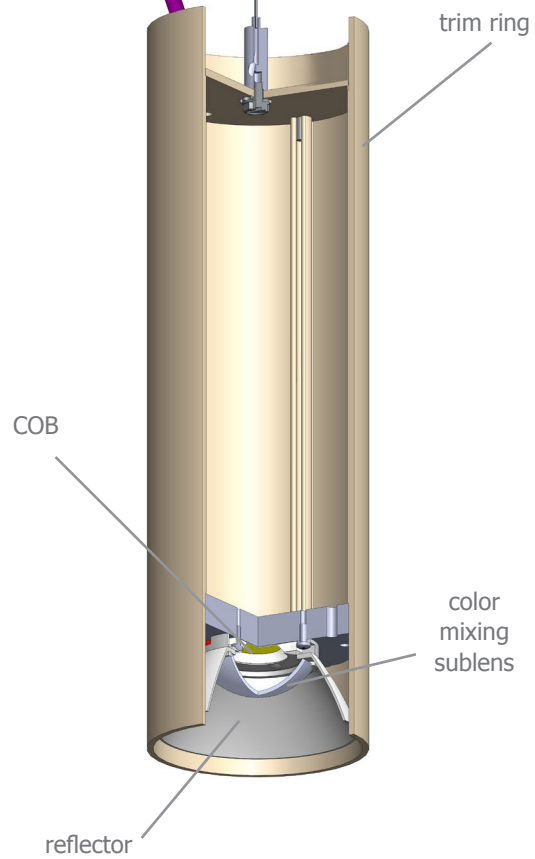
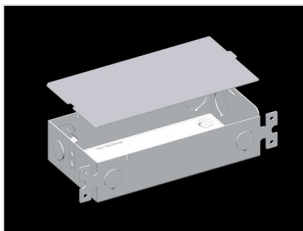

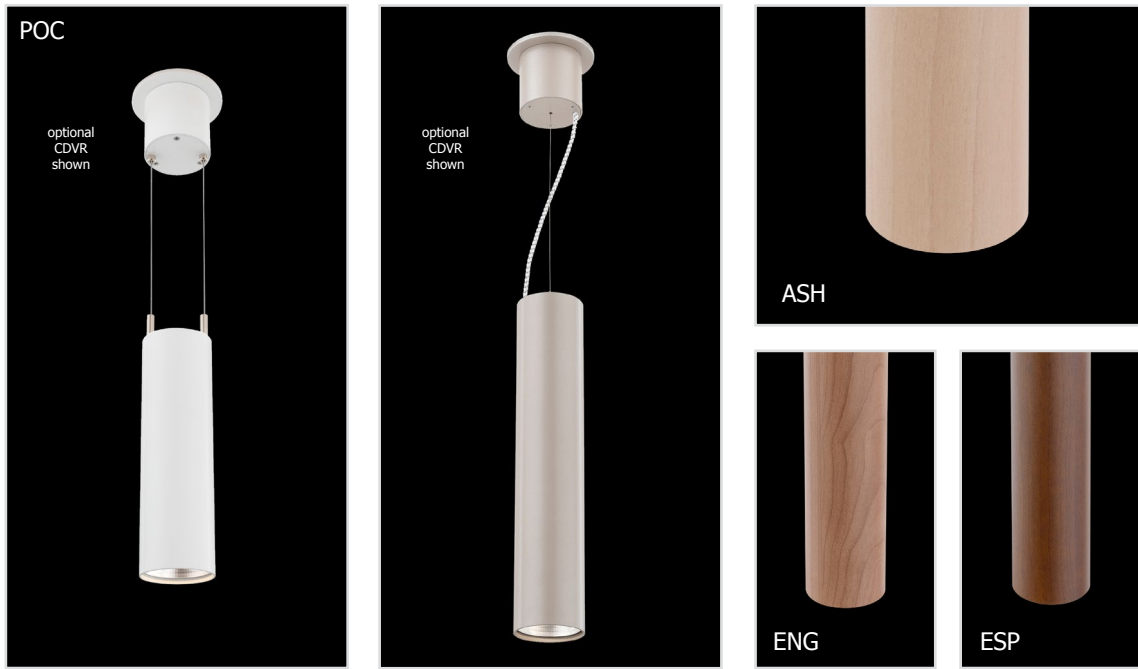

## Typical Lighting Layout

Statistics						
Description	Symbol	Avg	Max	Min	Max/Min	Avg/Min
na.row	+	27.1 fc	39.6 fc	18.5 fc	2.1:1	1.5:1

Schedule						
Symbol	Quantity	Manufacturer	Catalog Number	Description	Lamp	Wattage
	1	Impact Architectural Lighting	P7612 W 40 H3	12" length nar.ow downlight cylinder	4000k 90cri LED	28

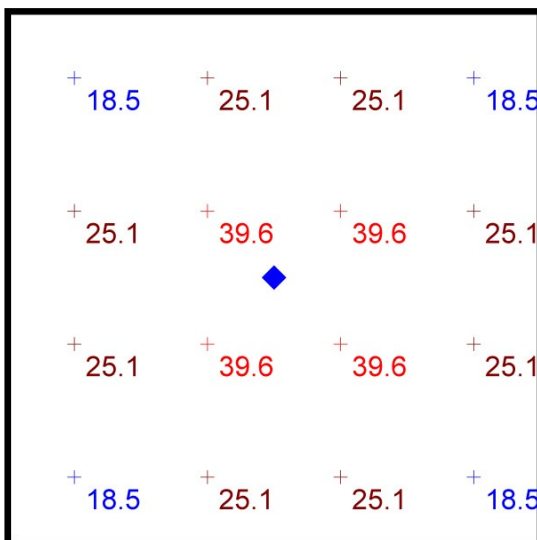

**Plan View**  
Scale - 1" = 2ft

- 8' x 8' x 12'H space
- 80/50/20 reflectances
- bottom of fixture at 10' aff
- FC readings at 2.5' aff
- layout conducted using P7612 with 90 CRI H3 (2780 lm) with wide beam spread



# Calculation Table

The application of a Light Loss Factor is required to:

- match the lumen output for the power module specified
- incorporate the increased lumen output due to LED/Driver upgrades

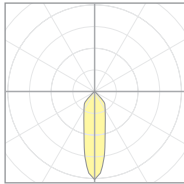

**20921**  
P7506-S-40H3  
**S** 20° spot

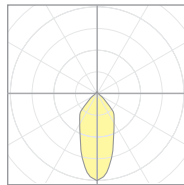

**20922**  
P7506-M-40H3  
**M** 30° med

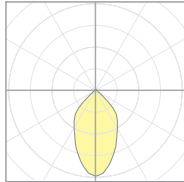

**20923**  
P7506-W-40H3  
**W** 50° wide

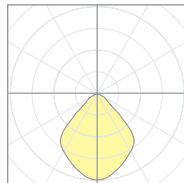

**20924**  
P7506-EW-40H3  
**XW** 90° extra wide

Cat No	Delivered* Lumens	Watts 120V / 277V	IES File #	LLF to be applied
<b>L1</b>	395	4	<b>20921</b> spot	.12
			<b>20922</b> med	.12
			<b>20923</b> wide	.12
			<b>20924</b> x-wide	.12
<b>L2</b>	695	7	<b>20921</b> spot	.22
			<b>20922</b> med	.22
			<b>20923</b> wide	.22
			<b>20924</b> x-wide	.22
<b>L3</b>	995	10	<b>20921</b> spot	.31
			<b>20922</b> med	.31
			<b>20923</b> wide	.31
			<b>20924</b> x-wide	.31
<b>H1</b>	1390	14	<b>20921</b> spot	.43
			<b>20922</b> med	.43
			<b>20923</b> wide	.43
			<b>20924</b> x-wide	.43
<b>H2</b>	1985	21	<b>20921</b> spot	.62
			<b>20922</b> med	.62
			<b>20923</b> wide	.62
			<b>20924</b> x-wide	.62
<b>H3</b>	2780	28	<b>20921</b> spot	.86
			<b>20922</b> med	.88
			<b>20923</b> wide	.88
			<b>20924</b> x-wide	.88

\*delivered lumens based on 4000K, 90+ cri

## Powder Coat Paint Finishes

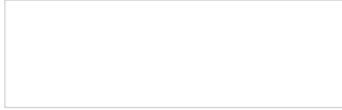

**MW** matte white

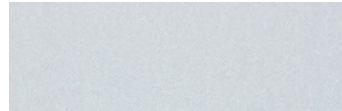

**AP** anodized paint

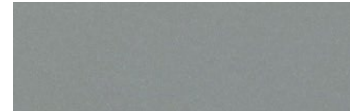

**SS** satin silver



**TG** textured gray



**FB** flat black

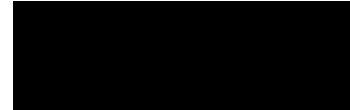

**SB** satin black

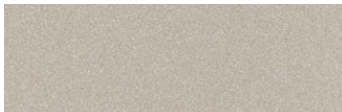

**CP** champagne

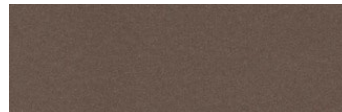

**BZ** bronze

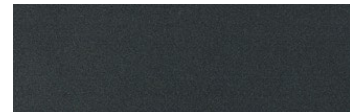

**GM** gun metal



**OR** orange 2011



**BU** blue 5017



**BS** brass



**RD** red 3020



**YO** yellow 1018



**MB** military blue

## Premium Finishes\*

### Wood Finishes

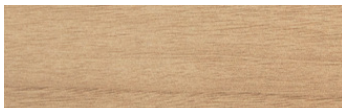

**ASH** ashwood

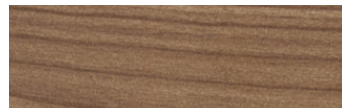

**ENG** english brown oak



**ESP** espresso

For accurate color verification, actual finish samples are available upon request.



**RAL#**

\*Available on select series. Consult product submittal for availability.