

job name:
 type:

str8™ spec sheet

material
 ribbed extruded aluminum outer housing in two lengths available in 2 anodized and 19 standard powder coat paint finishes listed below.

LED
 COB in 2700K, 3000K, 3500K, or 4000K (80 cri standard) (90 cri optional) rated >36,000 hours L70 (6.8K) per LM-80 test data, and 71,000 hours projected life per IES TM-21.

downlight optics
 LEDiL® Angelina 82mm dia 31mm high (RoHS compliant) available in 20° spot, 30° medium, 50° wide with specular anodized finish. 90° extra wide features matte white highly reflective finish. color mixing sublens standard. standard mounting clamp allows for easy replacement of reflector in field. the typical total beam angle is the full angle measured where the luminous intensity is half of the peak volume.

driver
 in canopy, constant current, class P, class 2 power unit, class A sound rating, universal input (120-277V) programmable driver, 5% minimum dimming level, PF >0.90. protections include short circuit, input/output isolation and surge protection (3KV). wired for 0-10v dimming from factory.

mounting
 extruded aluminum canopy painted to match fixture. ultrathin vertical stainless steel cable and field adjustable gripper that allow for exact AFF mounting heights. cloth-covered power cord color options listed below. cord requires special stripping tool (link).

power over cable (optional)
 Class 2 LED powered suspension system that suspends and powers the fixture with thin stainless steel copper-core conductive cables, providing a clean look without the need for a separate power cord. powered suspension requires cable cutter (link) specifically designed to cut stainless steel aircraft cable from 1/32" to 1/8".

finish
 select from 2 anodized and 19 standard powder coat paint finishes listed below or specify RAL# for custom colors.

emergency
 if required, recommend use of inverter (by other).

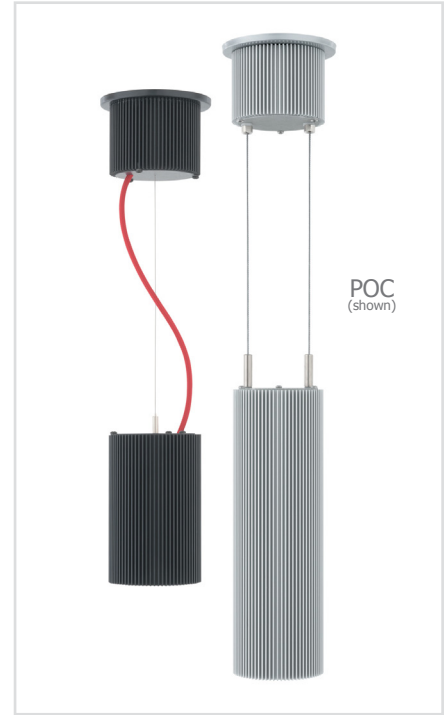

catalog number

--	--	--	--	--	--	--

size	beam	CCT	lumens	anodized finishes	power cord	options
P7506 4"dia X 6.5"ht	S 20° spot	27 2700K	L1 450 lm	AN silver anodized	BUPC blue cloth cord	3FT 36" cables
	M 30° med	30 3000K	L2 800 lm	ANB anodized black	ORPC orange cloth cord	6FT 72" cables
	W 50° wide	35 3500K	L3 1000 lm	painting finish	PLPC purple cloth cord	90CRI
P7512 4"dia X 12.75"ht	XW 90° extra wide	40 4000K	H1 1500 lm	BN brown	RDPC red cloth cord	
			H2 2200 lm	BR brick red	WGPC white & gray dot cloth cord	
			H3 3000 lm	BS brass	POC power over cable	
				BU blue		
				BZ bronze		
				CP champagne		
				GM gun metal		
				GR green		
				MB military blue		
				MN mint		
				MW matte white		
				OR orange		
				PL purple		
				RD red		
				SS satin silver		
				TG textured gray		
				TW textured white		
				YO yellow		

premium finish
RAL specify RAL#

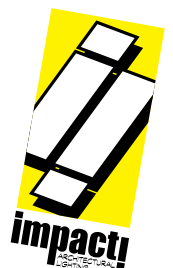

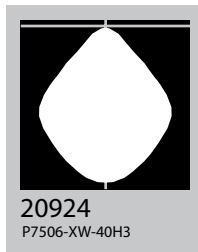
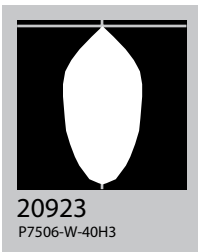
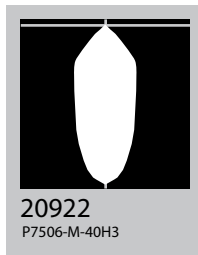
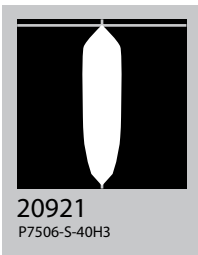
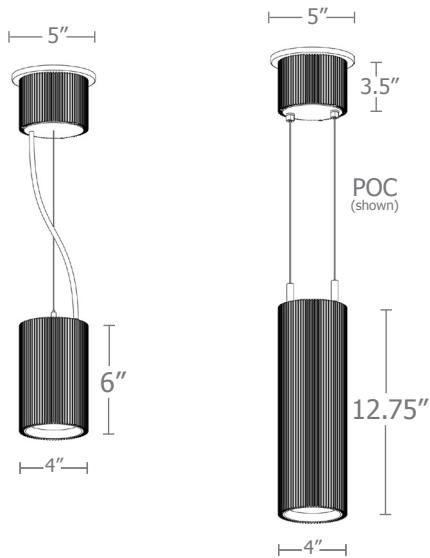

Watts 120V / 277V **Amps** 120V 277V

Cat No	Delivered* Lumens	Watts 120V / 277V	Amps 120V	Amps 277V
L1	450	4	.03	.01
L2	800	7	.06	.03
L3	1000	10	.08	.04
H1	1500	14	.12	.05
H2	2200	20	.17	.07
H3	3000	29	.24	.10
	S 20° spot	M 30° med	W 50° wide	XW 90° extra
ies file #	20921	20922	20923	20924

*delivered lumens based on 4000K, 80+ cri (90cri multiplier .83)

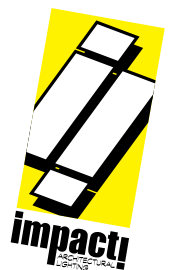

Powder Coat Paint Finishes

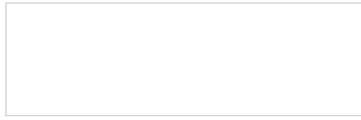

MW matte white



CP champagne



YO yellow 1018

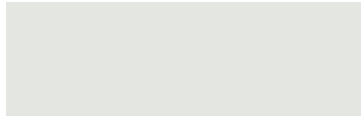

TW textured white

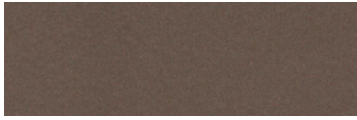

BZ bronze



RD red 3020

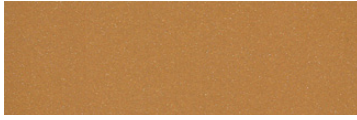

BS brass



BU blue 5017



SS satin silver



GM gun metal



OR orange 2011



TG textured gray



BR brick red



MN mint 6019



BN brown 8023



GR green 6018



MB military blue



PL purple 4005

For accurate color verification, actual finish samples are available upon request.

Premium Finishes*



RAL#

*Available on select series. Consult product submittal for availability.

