

job name:
 type:

12" miniskrt™ spec sheet 90CRI

material

housing

precision CNC spun .064" aluminum outer housing available in 15 standard powder coat paint finishes listed below.
 .060" aluminum liner powder coat painted high reflectance matte white.

diffuser

choose from .125" white acrylic or .064" spun aluminum powder coat painted high reflectance matte white.

LED

custom LED board in 3000K, 3500K, or 4000K (90+ cri standard). LEDs are rated >50,000 hours L70 (10K) at 85°C per LM-80 test data, and 70,000 hours projected life per IES TM-21. power cord color options listed below.

driver

in canopy, constant current, class P class 2 power unit, class A sound rating, universal input (120-277V) programmable driver, 1% minimum dimming level, PF >0.90. protections include short circuit, input/output isolation and surge protection (3KV). wired for 0-10v dimming from factory.

mounting

spun aluminum canopy painted to match fixture. three ultrathin vertical stainless steel cables and field adjustable grippers that allow for exact AFF mounting heights. cloth-covered power cord color options listed below. cord requires special stripping tool (link).

power over cable (optional)

Class 2 LED powered suspension system that suspends and powers the fixture with thin stainless steel copper-core conductive cables, providing a clean look without the need for a separate power cord. powered suspension requires cable cutter (link) specifically designed to cut stainless steel aircraft cable from 1/32" to 1/8".

finish

select from standard powder coat paint finishes or specify RAL# for custom colors.

emergency

if required, recommend use of inverter (by other).

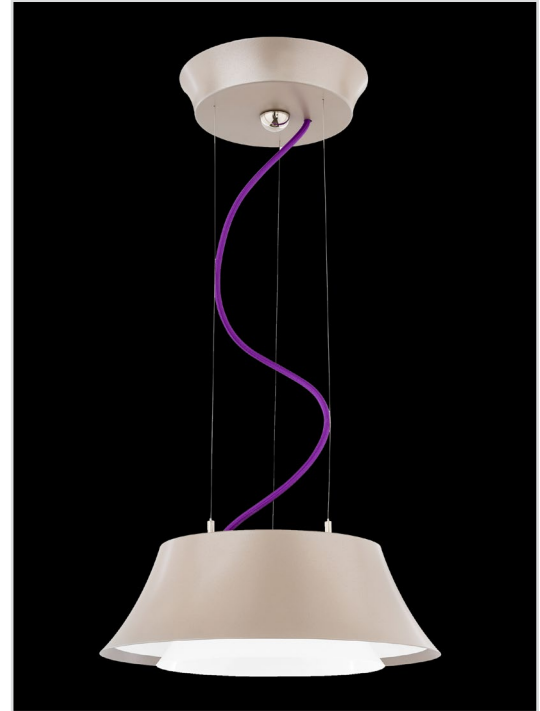

catalog number

P6112						
-------	--	--	--	--	--	--

size	diffuser	CCT	lumens	painting finish	power cord	options	
P6112 12.5"dia X 4.5"ht	A acrylic	30 3000K	LO 1120 lm	AP anodized paint	BUPC blue cloth cord	3FT 36" cables	
		35 3500K	HI 2615 lm	BS brass	ORPC orange cloth cord		
		40 4000K		BU blue	PLPC purple cloth cord		
	M metal		30 3000K	LO 910 lm	BZ bronze	RDPC red cloth cord	6FT 72" cables
			35 3500K	HI 2125 lm	CP champagne	WGPC white & gray dot cloth cord	
			40 4000K		FB flat black		
				GM gun metal	POC power over cable		
				MB military blue	WHPC white power cord and canopy		
				MW matte white	BKPC black power cord and canopy		
				OR orange	SBPC silver braid power cord and white canopy		
				RD red			
				SB satin black			
				SS satin silver			
				TG textured gray			
				YO yellow			
				premium finish			
				RAL specify RAL#			



job name:
 type:

16" miniskrt™ spec sheet 90CRI

material

housing

precision CNC spun .064" aluminum outer housing available in 15 standard powder coat paint finishes listed below.
 .060" aluminum liner powder coat painted high reflectance matte white.

diffuser

choose from .125" white acrylic or .064" spun aluminum powder coat painted high reflectance matte white.

LED

custom LED board in 3000K, 3500K, or 4000K (90+ cri standard). LEDs are rated >50,000 hours L70 (10K) at 85°C per LM-80 test data, and 70,000 hours projected life per IES TM-21. power cord color options listed below.

driver

in canopy, constant current, class P class 2 power unit, class A sound rating, universal input (120-277V) programmable driver, 1% minimum dimming level, PF >0.90. protections include short circuit, input/output isolation and surge protection (3KV). wired for 0-10v dimming from factory.

mounting

spun aluminum canopy painted to match fixture. three ultrathin vertical stainless steel cables and field adjustable grippers that allow for exact AFF mounting heights. cloth-covered power cord color options listed below. cord requires special stripping tool (link).

power over cable (optional)

Class 2 LED powered suspension system that suspends and powers the fixture with thin stainless steel copper-core conductive cables, providing a clean look without the need for a separate power cord. powered suspension requires cable cutter (link) specifically designed to cut stainless steel aircraft cable from 1/32" to 1/8".

finish

select from standard powder coat paint finishes or specify RAL# for custom colors.

emergency

if required, recommend use of inverter (by other).



catalog number

P6116						
size	diffuser	CCT	lumens	painting finish	power cord	options
P6116 16.25"dia X 5.75"ht	A acrylic	30 3000K 35 3500K 40 4000K	LO 2660 lm HI 3920 lm	AP anodized paint BS brass BU blue BZ bronze CP champagne FB flat black GM gun metal MB military blue MW matte white OR orange RD red SB satin black SS satin silver TG textured gray YO yellow	BUPC blue cloth cord ORPC orange cloth cord PLPC purple cloth cord RDPC red cloth cord WGPC white & gray dot cloth cord POC power over cable WHPC white power cord and canopy BKPC black power cord and canopy SBPC silver braid power cord and white canopy	3FT 36" cables 6FT 72" cables
	M metal	30 3000K 35 3500K 40 4000K	LO 2160 lm HI 3185 lm	premium finish RAL specify RAL#		



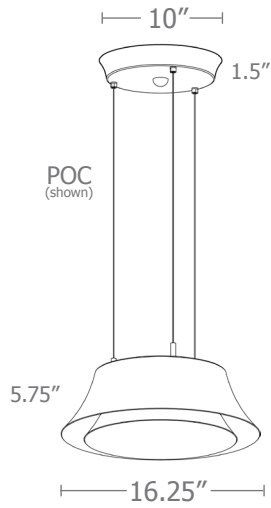
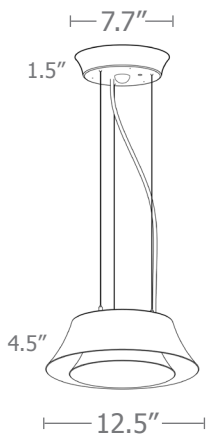

colored cloth cord

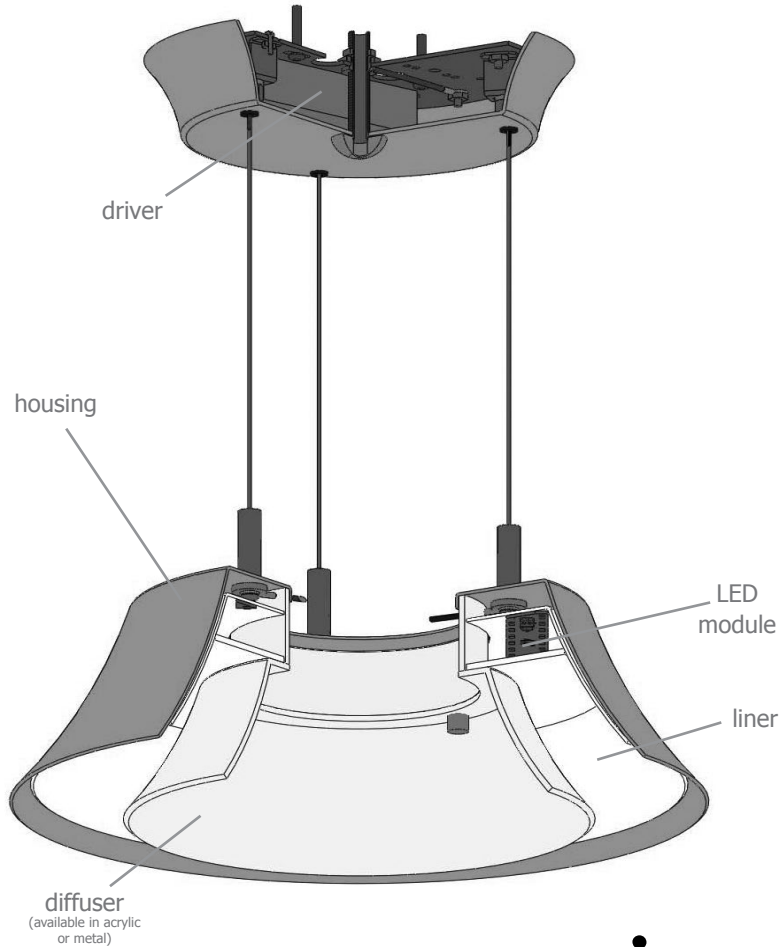

Typical Lighting Layout

Schedule					
Quantity	Manufacturer	Catalog Number	Description	Lamp	Wattage
1	Impact Architectural Lighting	P6116 A 40HI	16" dia. pendant minjskrt w/ acrylic diffuser	4000k 90cri LED	39

Statistics						
Description	Symbol	Avg	Max	Min	Max/Min	Avg/Min
minjskrt - acrylic	+	32.1 fc	36.5 fc	26.3 fc	1.4:1	1.2:1

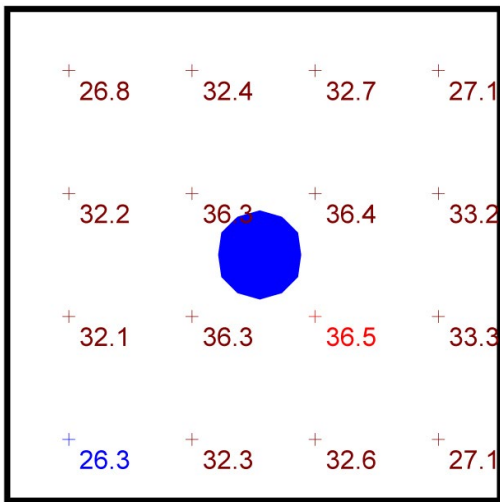

Plan View
Scale - 1" = 2ft

- 8' x 8' x 10'H space
- 80/50/20 reflectances
- bottom of fixture at 8' aff
- FC readings at 2.5' aff
- layout conducted using P6116 HI lumen 90 CRI package (3920 delivered lumens)



Calculation Table

The application of a Light Loss Factor is required to:

- match the lumen output for the power module specified
- incorporate the increased lumen output due to LED/Driver upgrades

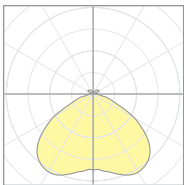

20913
P6112-A-40LO

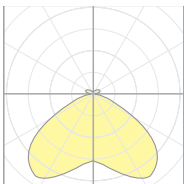

20914
P6112-M-40LO

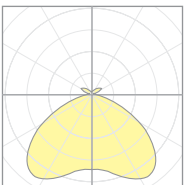

20919
P6116-A-40HI

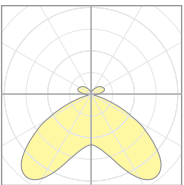

20920
P6116-M-40HI

Cat No	Delivered* Lumens	Watts 120V / 277V	IES File #	LLF to be applied
P6112-A LO	1120	12	20913	.90
P6112-A HI	2615	28	20915	.99
P6112-M LO	910	11	20914	.91
P6112-M HI	2125	26	20916	.99
P6116-A LO	2660	26	20917	.95
P6116-A HI	3920	39	20919	.99
P6116-M LO	2160	26	20918	1.02
P6116-M HI	3185	39	20920	1.06

*delivered lumens based on 4000K, 90+ cri

Powder Coat Paint Finishes



MW matte white



AP anodized paint

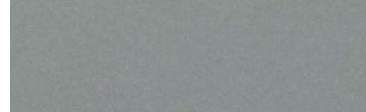

SS satin silver



TG textured gray

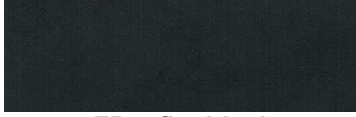

FB flat black



SB satin black



CP champagne



BZ bronze

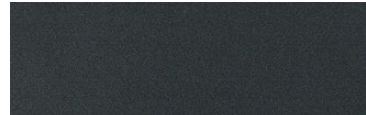

GM gun metal



OR orange 2011



BU blue 5017



BS brass



RD red 3020



YO yellow 1018



MB military blue

For accurate color verification, actual finish samples are available upon request.

Premium Finishes*



RAL#

*Available on select series. Consult product submittal for availability.