

job name:
 type:

24"/36"/48")(ula™ spec sheet 90CRI

material

trim ring

an hourglass curved profile with a soft bullnose bottom return. precision 6063 prime T5 aluminum extrusions roll-formed into a perfect circle. powder coated matte white (MW) finish.

diffuser

.118" thick laser cut optimum light diffusion acrylic. 72% light transmission with matte surface providing light scattering glare reduction. Colorless diffusion significantly reducing color shift of the LED's.

LED

custom LED board in 3000K, 3500K, or 4000K 90cri. employing Samsung 281B mid power LEDs. LEDs are rated >50,000 hours L70 (10K) at 85°C per LM-80 test data, and 70,000 hours projected life per IES TM-21. slim 5C (3-18/2-22) white power cord is standard with other color options listed below.

driver

constant current, class P class 2 power unit, class A sound rating, universal input (120-277V) programmable driver, 1% minimum dimming level, PF >0.90. protections include short circuit, input/output isolation and surge protection (3KV). wired for 0-10v dimming from factory.

mounting

5"dia. spun steel canopy in satin white. three point vertical suspension of 12 ft long stainless steel cables attach to trim with field adjustable grippers that allow for exact AFF mounting heights. optional tripod to single point cable suspension (TPD). see notes below.

finish

standard matte white powder coat painted finish. premium finish process for colored rings starts with matte white powder coat to preserve fixture performance. frame is masked to keep color from penetrating light chamber. top coat is then applied.

emergency

when required, recommend use of inverter (by other).



catalog number

size	direct LED CCT lumens	indirect LED CCT lumens	standard finish	options
P7424 (2ft) 24"dia X 4.5"ht	27 2700K LO 3240 lm 30 3000K HI 6480 lm 35 3500K CL xxxx lm custom lumens consult factory 40 4000K	27 2700K LO 1555 lm 30 3000K HI 3110 lm 35 3500K CL xxxx lm custom lumens consult factory 40 4000K	MW matte white premium finish RAL specify RAL #  RAL contact factory for information on gloss levels available.	BKPC Black power cord and canopy DCDM Dual circuit dimming (requires second power cord) FTL Frosted top lens SBPC Silver braid power cord and white canopy TPD Tripod hanging system**
P7436 (3ft) 36"dia X 4.5"ht	27 2700K LO 4860 lm 30 3000K HI 9720 lm 35 3500K CL xxxx lm custom lumens consult factory 40 4000K	27 2700K LO 2335 lm 30 3000K HI 4665 lm 35 3500K CL xxxx lm custom lumens consult factory 40 4000K		** tripod suspension requires min. leg length. see page 2 for details
P7448 (4ft) 48"dia X 4.5"ht (40 lbs)	27 2700K LO 6305 lm 30 3000K HI 12610 lm 35 3500K CL xxxx lm custom lumens consult factory 40 4000K	27 2700K LO 2970 lm 30 3000K HI 5940 lm 35 3500K CL xxxx lm custom lumens consult factory 40 4000K		

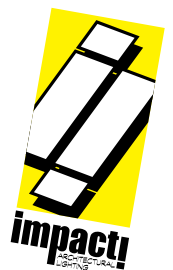

job name:
 type:

60"/72")(ula™ spec sheet 90CRI

material

trim ring
 an hourglass curved profile with a soft bullnose bottom return. precision 6063 prime T5 aluminum extrusions roll-formed into a perfect circle. powder coated matte white (MW) finish.

diffuser
 .118" thick laser cut optimum light diffusion acrylic. 72% light transmission with matte surface providing light scattering glare reduction. Colorless diffusion significantly reducing color shift of the LED's.

LED
 custom LED board in 3000K, 3500K, or 4000K 90cri. employing Samsung 281B mid power LEDs. LEDs are rated >50,000 hours L70 (10K) at 85°C per LM-80 test data, and 70,000 hours projected life per IES TM-21. slim 5C (3-18/2-22) white power cord is standard with other color options listed below.

driver
 constant current, class P class 2 power unit, class A sound rating, universal input (120-277V) programmable driver, 1% minimum dimming level, PF >0.90. protections include short circuit, input/output isolation and surge protection (3KV). wired for 0-10v dimming from factory.

mounting
 5"dia. spun steel canopy in satin white. three point vertical suspension of 12 ft long stainless steel cables attach to trim with field adjustable grippers that allow for exact AFF mounting heights. optional tripod to single point cable suspension (TPD). see notes below.

finish
 standard matte white powder coat painted finish. premium finish process for colored rings starts with matte white powder coat to preserve fixture performance. frame is masked to keep color from penetrating light chamber. top coat is then applied.

emergency
 when required, recommend use of inverter (by other).



catalog number

size	direct LED CCT lumens	indirect LED CCT lumens	standard finish	options
P7460* (5ft) 60"dia X 4.5"ht (50 lbs)	27 2700K LO 7920 lm 30 3000K HI 15840 lm 35 3500K CL xxxx lm custom lumens consult factory 40 4000K	27 2700K LO 4475 lm 30 3000K HI 8950 lm 35 3500K CL xxxx lm custom lumens consult factory 40 4000K	MW matte white premium finish RAL specify RAL #  RAL contact factory for information on gloss levels available.	BKPC Black power cord and canopy DCDM Dual circuit dimming (requires second power cord) FTL Frosted top lens SBPC Silver braid power cord and white canopy TPD Tripod hanging system**
P7472* (6ft) 72"dia X 4.5"ht (60 lbs) * requires structural mount	27 2700K LO 10025 lm 30 3000K HI 20050 lm 35 3500K CL xxxx lm custom lumens consult factory 40 4000K	27 2700K LO 5305 lm 30 3000K HI 10610 lm 35 3500K CL xxxx lm custom lumens consult factory 40 4000K		** tripod suspension requires min. leg length. see page 2 for details

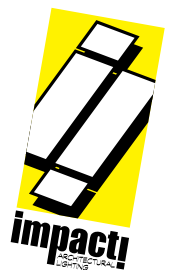

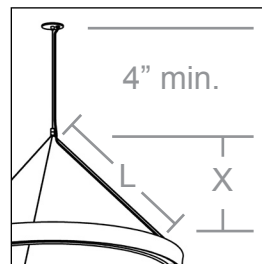
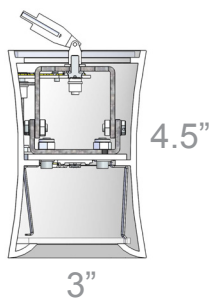
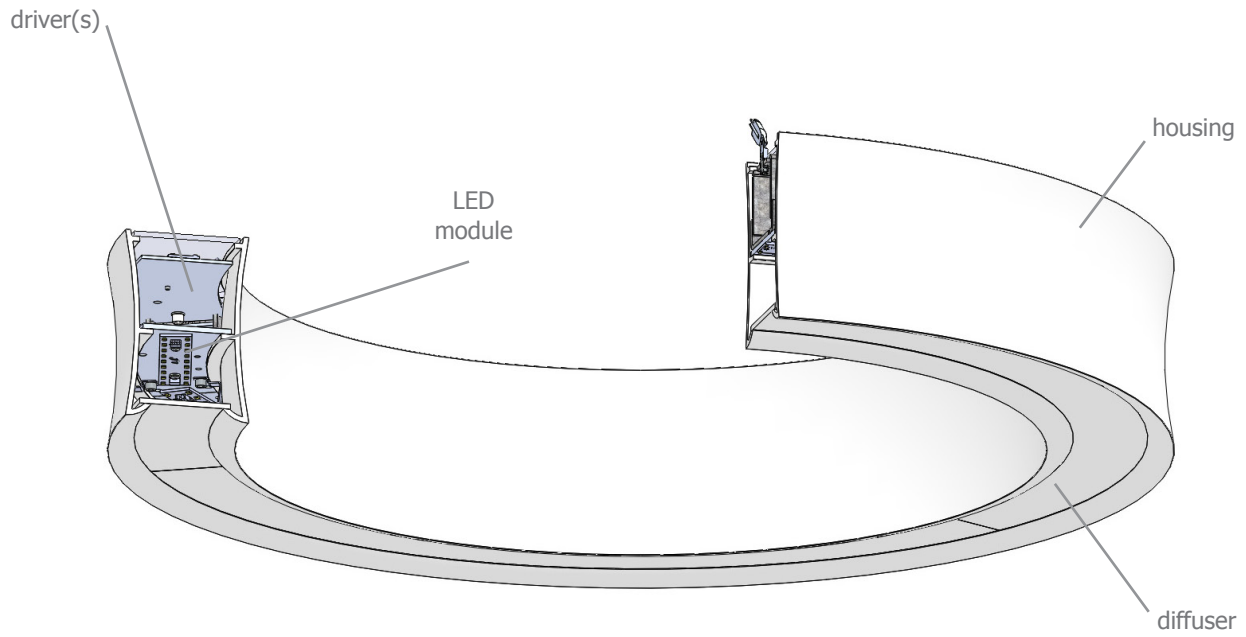
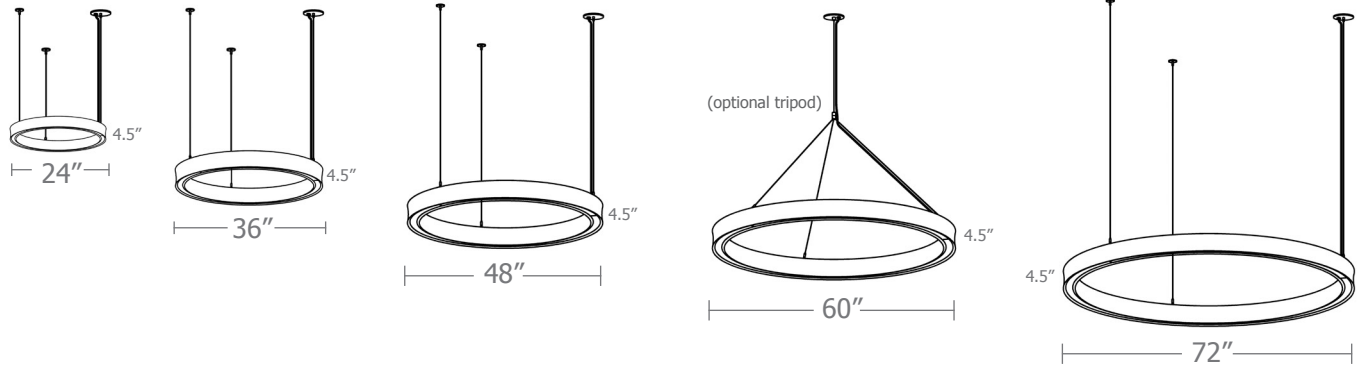

tripod suspension requires min. leg length.

	L	X
P7424	14" leg	6.5"
P7436	21" leg	10"
P7448	28" leg	14"
P7460	35" leg	17"
P7472	42" leg	21"

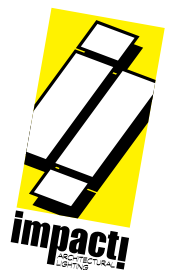

48" Typical Lighting Layout

- 16' x 16' x 16'H space
- 80/50/20 reflectances
- bottom of fixture at 12' aff
- FC readings at 2.5' aff
- layout conducted using HI / HI lumen package (12610 direct / 5940 indirect delivered lumens)

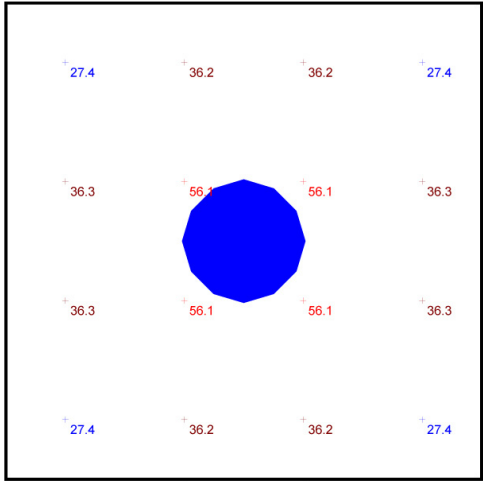

Plan View
Scale - 1" = 4ft

Statistics						
Description	Symbol	Avg	Max	Min	Max/Min	Avg/Min
(1) 4' dia)(ula	+	39.0 fc	56.1 fc	27.4 fc	2.0:1	1.4:1

Schedule						
Symbol	Quantity	Manufacturer	Catalog Number	Description	Lamp	Wattage
	1	Impact Architectural Lighting	P7448 40HI 40HI	48" dia. pendant ring)(ula luminaire w/ up/down dist.	4000k 90cri LED	211

72" Typical Lighting Layout

- 22' x 22' x 22'H space
- 80/50/20 reflectances
- bottom of fixture at 18' aff
- FC readings at 2.5' aff
- layout conducted using HI / HI lumen package (20050 direct / 10610 indirect delivered lumens)

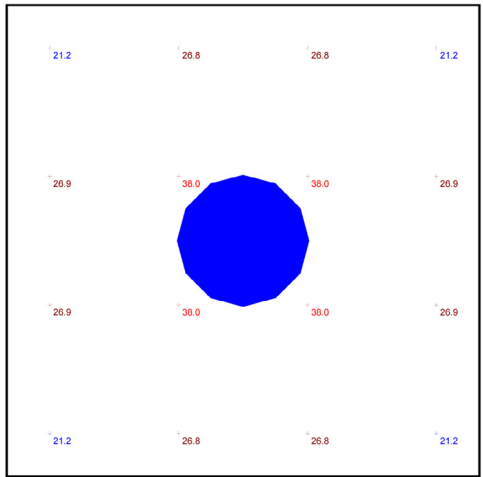

Plan View
Scale - 1" = 4ft

Statistics						
Description	Symbol	Avg	Max	Min	Max/Min	Avg/Min
(1) 6' dia)(ula	+	28.2 fc	38.0 fc	21.2 fc	1.8:1	1.3:1

Schedule						
Symbol	Quantity	Manufacturer	Catalog Number	Description	Lamp	Wattage
	1	Impact Architectural Lighting	P7472 40HI 40HI	72" dia. ring pendant)(ula luminaire w/ up/down dist.	4000k 90cri LED	333

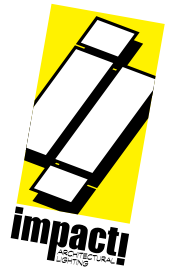

Quick Calc Table

Tests indicated below are a combination of direct and indirect. LLF are as close as possible.

for more detailed calculations see table on next page.

Cat No	Direct Delivered* Lumens	Indirect Delivered* Lumens	Watts 120V / 277V	IES File #	LLF to be applied
P7424	see Advanced Calc Table (next page)				
P7436					
P7448 LO LO	6305	2970	106	20538	.50
P7448 HI HI	12610	5940	213	20538	1.00
P7460 LO LO	7920	4475	142	20535	.40
P7460 HI HI	15840	8950	283	20535	.71
P7472 LO LO	10025	5305	174	20535	.50
P7472 HI HI	20050	10610	350	20535	1.00

*delivered lumens based on 4000K, 90+ cri

The application of a Light Loss Factor is required to:

- match the lumen output for the power module specified
- incorporate the increased lumen output due to LED/Driver upgrades

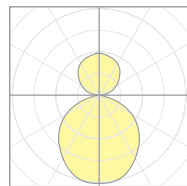

20538
P7448-40HI-40HI

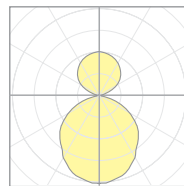

20535
P7472-40HI-40HI

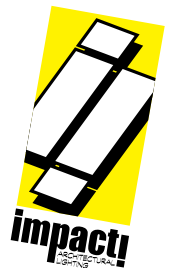

Advanced Calculation Table

Tests are for each element separately and must be "stacked" to represent single fixture
Consult factory for applications assistance

Direct

Cat No	Delivered* Lumens	Watts 120V/277V	IES File #	LLF to be applied
P7424	LO 3240	42	20774	.61
	HI 6480	86	20774	1.21
P7436	LO 4860	64	20776	.56
	HI 9720	129	20776	1.13
P7448	LO 6305	81	20539	.49
	HI 12610	162	20539	.99
P7460	LO 7920	105	20778	.57
	HI 15840	210	20778	1.14
P7472	LO 10025	133	20536	.50
	HI 20050	267	20536	1.00

Indirect

Delivered* Lumens	Watts 120V/277V	IES File #	LLF to be applied
LO 1555	13	20773	.53
HI 3110	25	20773	1.06
LO 2335	19	20775	.50
HI 4665	38	20775	.99
LO 2970	25	20540	.49
HI 5940	51	20540	.99
LO 4475	37	20777	.51
HI 8950	73	20777	1.01
LO 5305	41	20537	.51
HI 10610	83	20537	1.01

*delivered lumens based on 4000K, 90+ cri

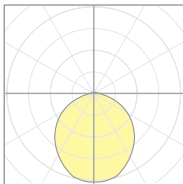

20539
P7448-40HI-NUL

The application of a Light Loss Factor is required to:

- match the lumen output for the power module specified
- incorporate the increased lumen output due to LED/Driver upgrades

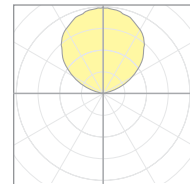

20540
P7448-NDL-40HI

