



ceiling mount  
**bul.it™ 5-slider**

your lighting rep has recommended  
the **ceiling mount bul.it™** fixture  
for your project  
Let's take a quick look:



## sizes and lumens

**C3312**



**C3316**

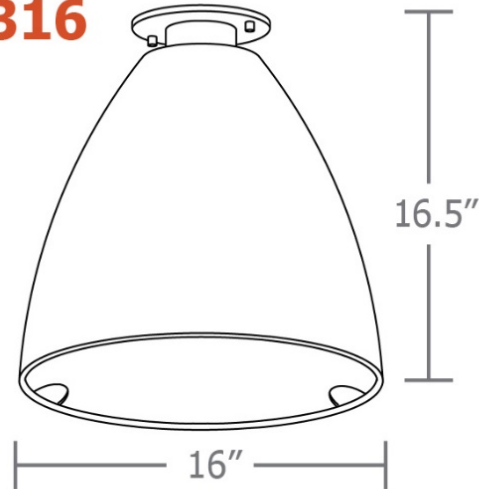

- C3312 (12") / 1000 – 3500 lm
- C3316 (16") / 1600 – 5000 lm



## construction

integral programmable driver,  
constant current, field maintainable,  
input voltage 120-277V, 0-10v  
controllable, 1% dimming.

single COB LED module in 80+ CRI  
standard or optional 90 CRI  
2700K, 3000K, 3500K, and 4000K

.050" spun aluminum conical  
reflector finished in high  
reflectance (>92%) matte white  
powder coat

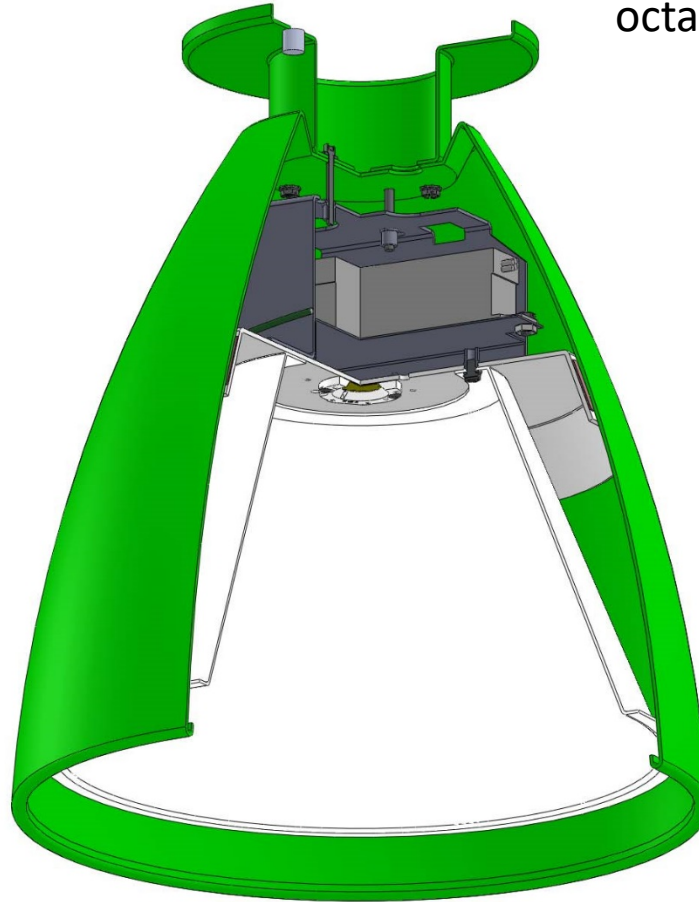

mounts to standard 4"  
octagon junction box

precision CNC spun .063" aluminum  
parabolic housing with rolled  
bottom edge for added strength

21 standard powder  
coat paint finishes  
+ custom RAL colors

open bottom, frosted acrylic flat lens, or  
open with decorative colored ring in  
amber, blue, frost, green, red, or yellow

ceiling mount  
**bul.it™ 5-slider**



# performance

Statistics						
Description	Symbol	Avg	Max	Min	Max/Min	Avg/Min
ceiling mount bul.it	+	24.2 fc	37.8 fc	15.3 fc	2.5:1	1.6:1

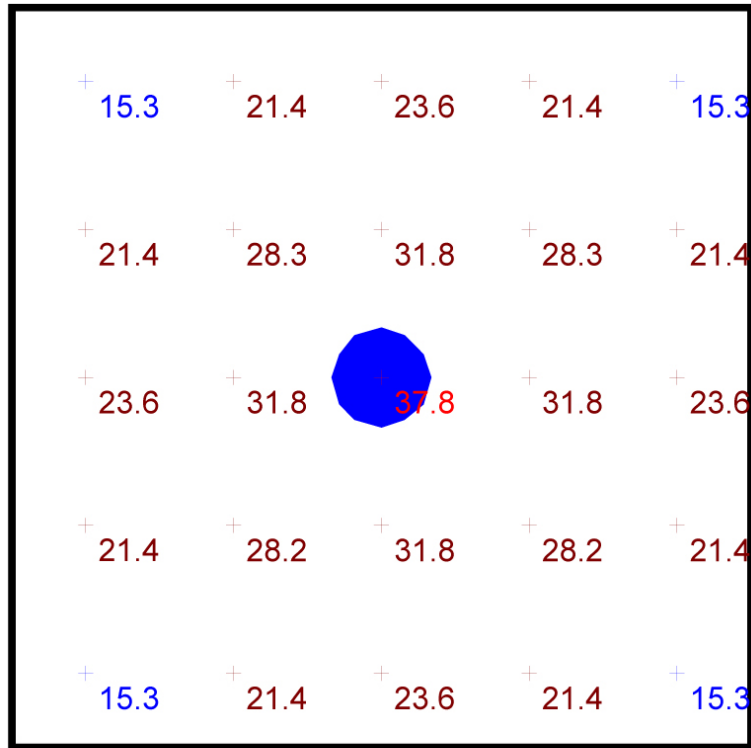

Plan View  
Scale - 1" = 2ft

- 10' x 10' x 14'H space
- 80/50/20 reflectances
- bottom of fixture at 12.5' aff
- FC readings at 2.5' aff
- layout conducted using C3316 HI output (3700 delivered lumens)













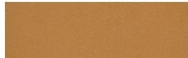

ceiling mount  
bul.it™ 5-slider





**Powder Coat Paint Finishes**

 MW matte white	 CP champagne	 YO yellow 1018
 TW textured white	 BZ bronze	 RD red 3020
 AP anodized paint	 BS brass	 BU blue 5017
 SS satin silver	 GM gun metal	 OR orange 2011
 TG textured gray	 BR brick red	 MN mint 6019
 FB flat black	 BN brown 8023	 GR green 6018
 SB satin black	 MB military blue	 PL purple 4005



[www.impactltg.com](http://www.impactltg.com)

- spec sheet and color chart
- photometric files and BIM models
- built to order in Saint Louis, MO, USA
- 4-week lead time

ceiling mount  
**bul.it™ 5-slider**

