

job name:
 type:

circ.us™ spec sheet

material

housing

precision CNC spun .063" aluminum. rolled bottom edge for added strength.

diffuser

.125" virgin matte white acrylic panels, with clear spacer disc.

optics

reflector

segmented .050 aluminum painted high reflectance powder coat matte white.

lamp lens

.125" P95 frost acrylic lens.

LED

custom LED board in 3000K, 3500K, or 4000K (80+ cri standard) optional 90cri (see below). under normal operating conditions, the LEDs employed are rated for >50,000hrs L70 (6.8K) per IES TM-21 from LM-80 test data. white power cord is standard with other color options listed below.

driver

integral, programmable, UL class P, class 2, universal input (120-277v), constant current, 0-10v dimming, 1% minimum dimming level, PF >.9, THD <20%, protections include open and short circuit, overload and over temperature.

mounting

5"dia. spun steel canopy in satin white. four point vertical suspension of 12 ft long stainless steel cables attach to trim with field adjustable grippers that allow for exact AFF mounting heights. optional quadpod to single point cable suspension, with sloped ceiling adapter.

emergency

recommend use of inverter (by other).



catalog number

--	--	--	--

size

- P6726**
(2ft) 26.75"dia X 9"ht
- P6738**
(3ft) 38.75"dia X 11"ht
- P6748**
(4ft) 48.75"dia X 13"ht

LED array

- 30LO** 3000K
30HI 3000K
- 35LO** 3500K
35HI 3500K
- 40LO** 4000K
40HI 4000K
- CL** xxxx lm
custom lumens
consult factory

finish

- AP** anodized paint
BN brown
BR brick red
BS brass
BU blue
BZ bronze
CP champagne
FB flat black
GM gun metal
GR green
MB military blue
MN mint
MW matte white
OR orange
PL purple
RD red
SB satin black
SS satin silver
TG textured gray
TW textured white
YO yellow

options

- 90CRI**
- QPD** Quadpod hanging system
- BKPC** Black power cord and canopy
- SBPC** Silver braid power cord and white canopy

premium finish

- BA** brushed aluminum
RAL specify RAL#

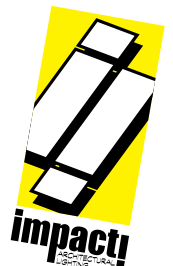

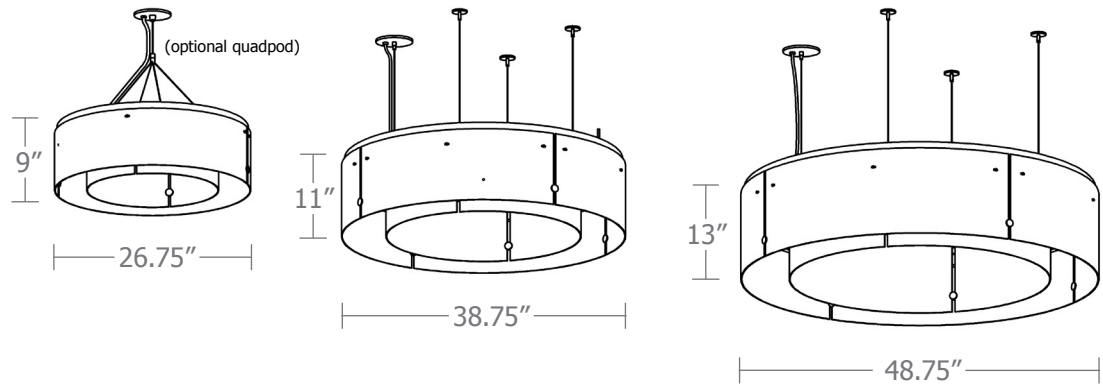

Cat No	Delivered Lumens	Watts		Amps	
		120V / 277V	120V	277V	
P6726 LO	2809	30	0.25	0.11	
P6726 HI	5461	55.8	0.47	0.20	
P6738 LO	3414	37	0.31	0.13	
P6738 HI	6827	73	.61	0.26	
P6748 LO	5300	59	.49	.21	
P6748 HI	9300	104	.87	.38	

*delivered lumens based on 4000K, 80+ cri
(90cri multiplier .83)

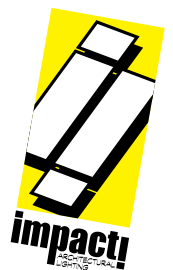

Powder Coat Paint Finishes

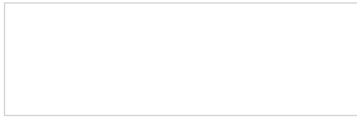

MW matte white



CP champagne



YO yellow 1018

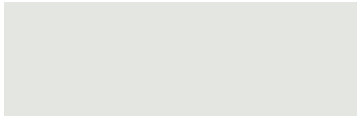

TW textured white



BZ bronze



RD red 3020

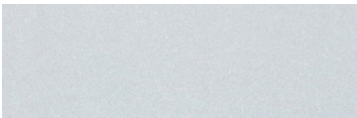

AP anodized paint



BS brass



BU blue 5017

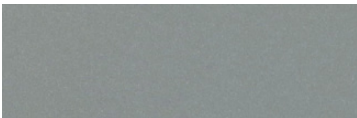

SS satin silver

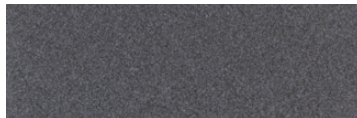

GM gun metal



OR orange 2011

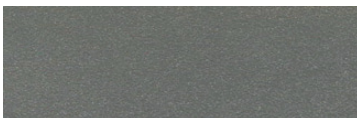

TG textured gray



BR brick red



MN mint 6019

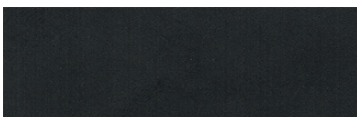

FB flat black



BN brown 8023



GR green 6018



SB satin black



MB military blue



PL purple 4005

For accurate color verification, actual finish samples are available upon request.

Premium Finishes*



BA brushed aluminum



RAL#

*Available on select series. Consult product submittal for availability.

