

job name:
 type:

n.r.2oob™ LED spec sheet

material

trim ring

precision CNC spun .063" aluminum. rolled top edge for added strength.

diffuser

.125" virgin white acrylic inner lens.

optics

reflector

22 gauge aluminum powder coat painted high reflectance white.

efficiency

constant current driver operates LED consistently, regulating the current flow through it to produce the most consistent light output and efficiency. constant current driver protects LEDs from voltage fluctuations in the building power system, eliminating stress from over voltage, inrush surges, and flicker from voltage fluctuations, assuring long service life.

LED

custom LED board in 3000K, 3500K, or 4000K (80 cri). under normal operating conditions, the LEDs employed are rated for >36,000hrs L70 (6.8K) per IES TM-21 from LM-80 test data, and 71,000hrs L70 projected life. white power cord is standard with other color options listed below.

driver

Roal Strato series, class 2 power unit, built-in active PFC function, universal input (120-277 vac), 10% minimum dimming level, PF >80, protections include short circuit, over current, over voltage and over temperature. wired for 0-10v dimming from factory.

mounting

5"dia. spun steel canopy in satin white. four point vertical suspension of 12 ft long stainless steel cables attach to trim with field adjustable grippers that allow for exact AFF mounting heights. optional quadpod to single point cable suspension.

emergency

emergency not available. if required, recommend use of inverter (by other).



catalog number

--	--	--	--

size	LED array	finish	options
P6426 (2ft) 26"dia X 4"ht	30LO 3000K 30HI 3000K	AP anodized paint BR brick red BU blue BZ bronze CP champagne MB military blue MN mint MW matte white OR orange RD red SB satin black SS satin silver TG textured gray TW textured white YO yellow	QPD Quadpod hanging system SBPC Silver braid power cord and white canopy
P6438 (3ft) 38"dia X 5.5"ht	35LO 3500K 35HI 3500K		
P6448 (4ft) 48"dia X 7"ht	40LO 4000K 40HI 4000K		

Premium Finish

- BA** brushed aluminum
- RAL** specify RAL#
- KNP** knotty pine
- MED** mediterranean
- MHG** mahogany
- MPL** maple
- WAL** walnut
(extended lead time typical for wood finishes)

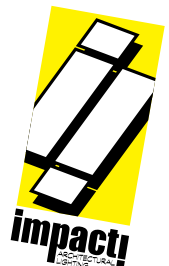

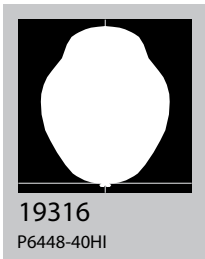
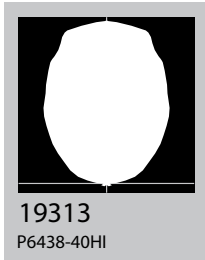
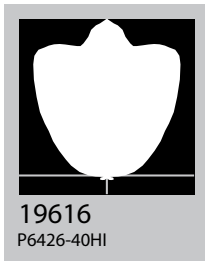
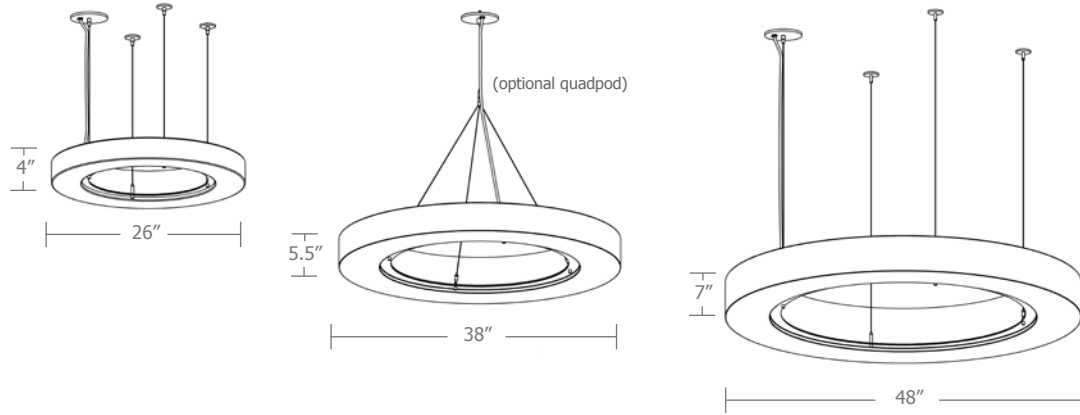

Cat No	Delivered Lumens	Watts		Amps	
		120V	277V	120V	277V
P6426 LO		29	29	0.24	0.10
4000K	3838				
3500K	3646				
3000K	2879				
P6426 HI		54	54	0.45	0.19
4000K	7147	ies file # 19616			
3500K	6790				
3000K	5360				
P6438 LO		33.5	33.5	0.28	0.12
4000K	3902				
3500K	3647	ies file # 19311			
3000K	2918				
P6438 HI		71.6	71.6	.60	0.26
4000K	7571	ies file # 19313			
3500K	7386	ies file # 19312			
3000K	5678				
P6448 LO		53.4	53.4	.45	0.19
4000K	6838				
3500K	6391	ies file # 19314			
3000K	5113				
P6448 HI		96.1	96.1	.80	0.35
4000K	11242	ies file # 19316			
3500K	10698	ies file # 19315			
3000K	8432				

Powder Coat Paint Finishes

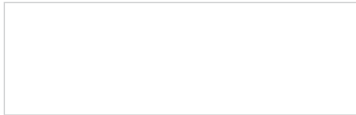

MW matte white

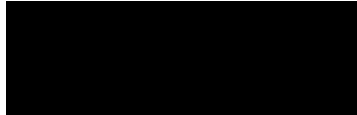

SB satin black



YO yellow 1018

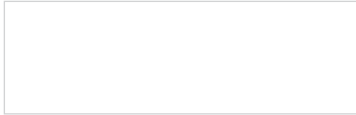

TW textured white



CP champagne



RD red 3020



AP anodized paint



BZ bronze



BU blue 5017



SS satin silver



BR brick red



OR orange 2011



TG textured gray



MB military blue



MN mint 6019

For accurate color verification, actual finish samples are available upon request.

Premium Finishes*



BA brushed aluminum



RAL#



MED mediterranean



KNP knotty pine



MPL maple



WAL walnut



MHG mahogany

For accurate color verification, actual finish samples are available upon request.

*Available on select series. Consult product spec sheet for availability.

(extended lead time typical for wood finishes)

