

tiki™ LED spec sheet

material

housing

two-piece precision CNC spun .063" aluminum. downlight housing with rolled bottom edge for added strength. inverted bell uplight element.

downlight array platform

.080" spun aluminum.

bottom lens (optional)

.125" P95 frosted acrylic concave dome with 3 finger holes. recesses slightly into fixture.

optics

.050" spun aluminum conical reflector finished in high reflectance (>92%) matte white powder coat.

efficiency

integral constant current driver operates LED consistently, regulating the current flow through it to produce the most consistent light output and efficiency. constant current driver protects LEDs from voltage fluctuations in the building power system, eliminating stress from over voltage, inrush surges, and flicker from voltage fluctuations, assuring long service life.

LED

COB array in 3000K, 3500K, or 4000K (80 cri). under normal operating conditions, the LEDs employed are rated for >36,000hrs L70 (6.8K) per IES TM-21 from LM-80 test data, and 71,000hrs L70 projected life. white power cord is standard with other color options listed below. for dual circuit wiring on direct/indirect dimming luminaires, specify under options.

driver

Roal Strato series, class 2 power unit, built-in active PFC function, universal input (120-277 vac), 10% minimum dimming level, PF >80, protections include short circuit, over current, over voltage and over temperature. wired from factory for 0-10v dimming. (9" dia)

integral Thomas Research LED-20W, LED-25W, LED-40W series, class 2 power unit, universal input (120-277 vac), 10% minimum dimming level, PF >.90, THD <20% at full load, >418khrs MTBF, protections include short circuit, over current, over voltage. wired for 0-10v dimming from factory. see options below for dual circuit dimming. (13" dia/17" dia)

mounting

5"dia. spun steel canopy in satin white with 6ft stainless steel cable tripod and field adjustable grippers that allow for exact AFF mounting heights.

finish

9" dia, select from standard powder coat paint finishes or specify RAL# for custom colors. silver anodized finish available by special order. minimum quantity required.

13" dia / 17" dia, standard is silver anodized finish. optionally, select from standard powder coat paint finishes or specify RAL# for custom colors.

emergency

emergency not available. if required, recommend use of inverter (by other).



catalog number

--	--	--	--	--

size

P5109

9"dia X 11.25"ht

see page 2 for info on P5113 and P5117

direct LED

30LO 3000K

30HI 3000K

35LO 3500K

35HI 3500K

40LO 4000K

40HI 4000K

indirect LED

30UP 3000K

35UP 3500K

40UP 4000K

NUL no up light

painted finishes

AP anodized paint

BR brick red

BU blue

BZ bronze

CP champagne

MB military blue

MN mint

MW matte white

OR orange

RD red

SB satin black

SS satin silver

TG textured gray

TW textured white

YO yellow

options

DCDM dual circuit wiring on dimming direct/indirect (requires 2nd power cord)

BKPC Black power cord and canopy

SBPC Silver braid power cord and white canopy

BL Bottom lens

DRA amber decorative ring

DRB blue decorative ring

DRF frost decorative ring

DRG green decorative ring

DRR red decorative ring

DRY yellow decorative ring

premium finish

RAL specify RAL#

AN silver anodized*
*min. order required

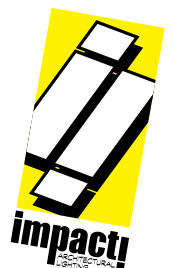

tiki™ LED spec sheet

catalog number

size
P5113
 13"dia X 16"ht

P5117
 17"dia X 21"ht

direct LED

- 30LO** 3000K
- 30HI** 3000K
- 35LO** 3500K
- 35HI** 3500K
- 40LO** 4000K
- 40HI** 4000K

indirect LED

- 30LO** 3000K
- 30HI** 3000K
- 35LO** 3500K
- 35HI** 3500K
- 40LO** 4000K
- 40HI** 4000K
- NUL** no up light

standard finish

AN silver anodized

painted finishes

- BR** brick red
- BU** blue
- BZ** bronze
- CP** champagne
- MB** military blue
- MN** mint
- MW** matte white
- OR** orange
- RD** red
- SB** satin black
- SS** satin silver
- TG** textured gray
- TW** textured white
- YO** yellow

premium finish

RAL specify RAL#

options

- DCDM** dual circuit wiring on dimming direct/indirect (requires 2nd power cord)
- BKPC** Black power cord and canopy
- SBPC** Silver braid power cord and white canopy
- BL** Bottom lens
- DRA** amber decorative ring
- DRB** blue decorative ring
- DRF** frost decorative ring
- DRG** green decorative ring
- DRR** red decorative ring
- DRY** yellow decorative ring

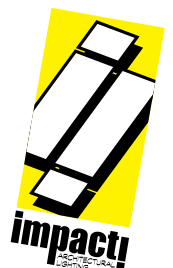
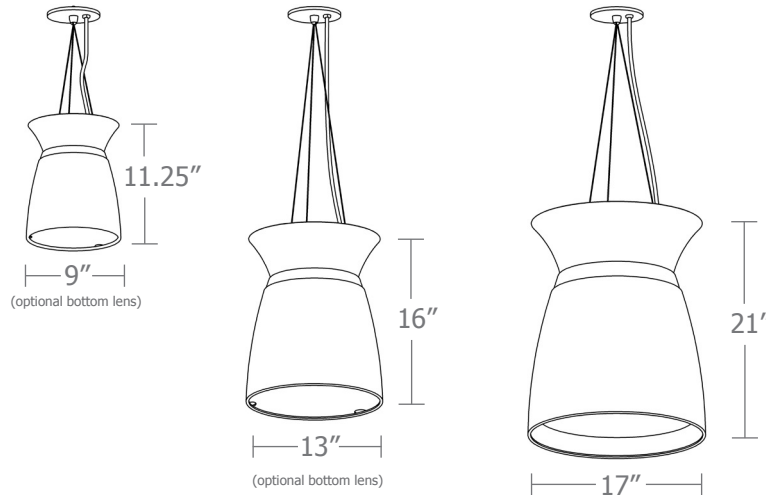

Cat No	Direct Delivered Lumens	Watts		Amps		Indirect Delivered Lumens*	Watts		Amps	
		120V/277V	120V	277V	120V/277V		120V	277V		
P5109 LO		13	.11	.05		5	.05	.02		
4000K	1125				1317					
3500K	1100				1290					
3000K	1080				1264					
P5109 HI		19	.16	.07		9	.08	.04		
4000K	2212				1317					
3500K	2168				1290					
3000K	2124				1264					

Cat No	Direct Delivered Lumens	Watts		Amps		Indirect Delivered Lumens*	Watts		Amps	
		120V/277V	120V	277V	120V/277V		120V	277V		
P5113 LO		39	.32	.14		22	.19	.08		
4000K	2796				1636					
3500K	2621				1534					
3000K	2092				1224					
P5113 HI		46	.38	.17		29	.24	.10		
4000K	3335	ies file # 18439			2082	ies file # 18439				
3500K	3127				1952					
3000K	2496				1558					
P5117 LO		39	.32	.14		22	.19	.08		
4000K	2796				1636					
3500K	2621				1534					
3000K	2092				1224					
P5117 HI		46	.38	.17		29	.24	.10		
4000K	3335				2082					
3500K	3127				1952					
3000K	2496				1558					

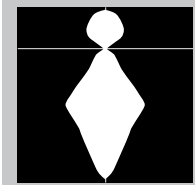

18439
P5113-40HI/40HI

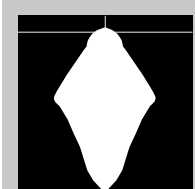

18440
P5113-40HI/NUL

Powder Coat Paint Finishes

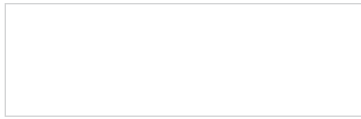

MW matte white



SB satin black



YO yellow 1018

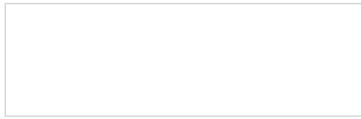

TW textured white



CP champagne



RD red 3020



AP anodized paint



BZ bronze



BU blue 5017



SS satin silver



BR brick red



OR orange 2011



TG textured gray



MB military blue



MN mint 6019

For accurate color verification, actual finish samples are available upon request.

Premium Finishes



RAL#

