

job name:
 type:

fun.l™ LED spec sheet

driver housing

extruded aluminum with silver anodized or black anodized finish, acts as heat sink as well. also available in painted finishes listed below.

diffuser

6" dia. .100" clear acrylic cylinder solvent welded to 10" dia gloss white acrylic cone.

efficiency

center beam power greater than compact fluorescent with up to 60% less energy consumption. constant current driver operates LED consistently, regulating the current flow through it to produce the most consistent light output and efficiency. constant current driver protects LEDs from voltage fluctuations in the building power system, eliminating stress from over voltage, inrush surges, and flicker from voltage fluctuations, assuring long service life.

modular construction

Molex solder-less holder allows for LED module replacement in the field. modular fixture design allows driver to be replaced in the field.

LED module

COB array in 3000K, 3500K, or 4000K (80 cri). under normal operating conditions, the LEDs employed are rated for >36,000hrs L70 (6.8K) per IES TM-21 from LM-80 test data, and 71,000hrs L70 projected life. contact factory for 90CRI options. white power cord is standard with other color options listed below.

driver

integral, class 2 power unit, built-in active PFC function, universal input (up to 305 vac), 10% minimum dimming level, PF >92, THD <20% at full load, >418khrs MTBF, protections include short circuit, over current, over voltage and over temperature. wired for 0-10v dimming from factory.

mounting

5"dia. spun steel canopy in satin white with single or optional dual 12ft stainless steel cables and field adjustable grippers that allow for exact AFF mounting heights. (min 1" from top of cylinder to ceiling)

emergency

emergency not available. if required, recommend use of inverter (by other).



catalog number

--	--	--	--

size

P9712 10"dia X 12"ht

LED array

30FX 3000K

30LO 3000K

35FX 3500K

35LO 3500K

40FX 4000K

40LO 4000K

powerhead finish

AN silver anodized

ANB anodized black

painted finish

BR brick red

BU blue

BZ bronze

CP champagne

MB military blue

MN mint

MW matte white

OR orange

RD red

SS satin silver

TG textured gray

TW textured white

YO yellow

premium finish

RAL specify RAL#

options

BKPC Black power cord and canopy

SBPC Silver braid power cord and white canopy

VHS 2-point vertical hanging system

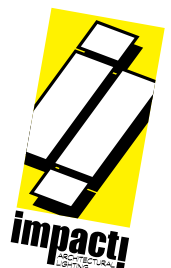
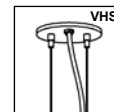

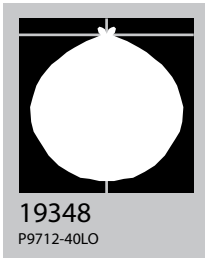
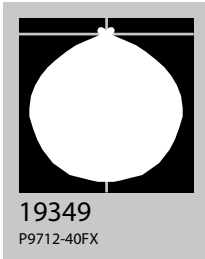
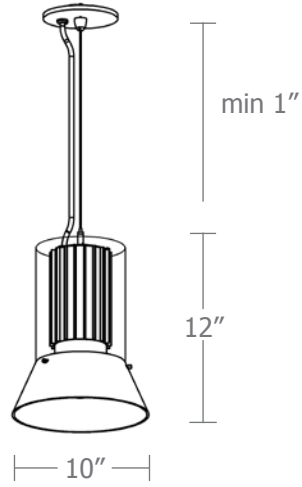

Cat No	Delivered Lumens	Watts		Amps	
		120V	277V	120V	277V
P9712 FX		17	17	.17	.07
4000K	1064	ies file # 19349			
3500K	1000				
3000K	915				
P9712 LO		27	27	.23	.10
4000K	1436	ies file # 19348			
3500K	1350				
3000K	1235				

Powder Coat Paint Finishes

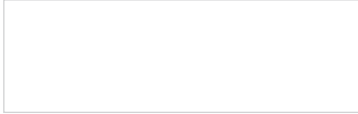

MW matte white

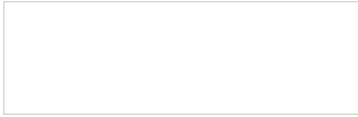

TW textured white

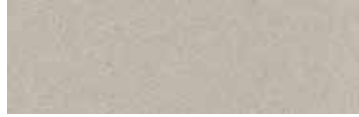

CP champagne



YO yellow 1018



RD red 3020



BZ bronze



BU blue 5017



SS satin silver



BR brick red



OR orange 2011



TG textured gray



MB military blue



MN mint 6019

For accurate color verification, actual finish samples are available upon request.

Premium Finishes*



RAL#

For accurate color verification, actual finish samples are available upon request.

*Available on select series. Consult product spec sheet for availability.

