

job name:   
 type:

## mel.o.iii™ LED spec sheet

### driver housing

extruded aluminum with silver anodized or black anodized finish, acts as heat sink as well. also available in painted finishes listed below.

### diffuser

.25" parabolic matte white acrylic with .125" matte white acrylic convex diffuser and .187" pattern 12 prismatic clear acrylic concave dome.

### bottom lens (optional)

P95 frosted acrylic bottom lens solvent welded to bottom of parabolic diffuser.

### efficiency

center beam power greater than compact fluorescent with up to 60% less energy consumption. constant current driver operates LED consistently, regulating the current flow through it to produce the most consistent light output and efficiency. constant current driver protects LEDs from voltage fluctuations in the building power system, eliminating stress from over voltage, inrush surges, and flicker from voltage fluctuations, assuring long service life.

### modular construction

Molex solder-less holder allows for LED module replacement in the field. modular fixture design allows driver to be replaced in the field.

### LED module

COB array in 3000K, 3500K, or 4000K (80 cri). under normal operating conditions, the LEDs employed are rated for >36,000hrs L70 (6.8K) per IES TM-21 from LM-80 test data, and 71,000hrs L70 projected life. contact factory for 90CRI options. white power cord is standard with other color options listed below.

### driver

integral, class 2 power unit, built-in active PFC function, universal input (up to 305 vac), 10% minimum dimming level, PF >92, THD <20% at full load, >418khrs MTBF, protections include short circuit, over current, over voltage and over temperature. wired for 1-10v dimming from factory.

### mounting

5"dia. spun steel canopy in satin white with single or optional dual 12ft stainless steel cables and field adjustable grippers that allow for exact AFF mounting heights.

### emergency

emergency not available. if required, recommend use of inverter (by other).



## catalog number

<input type="text"/>	<input type="text"/>	<input type="text"/>	<input type="text"/>	<input type="text"/>
----------------------	----------------------	----------------------	----------------------	----------------------

### size

**P8718** 18"dia X 17"ht

**P8727** 27"dia X 21"ht

### concave dome

**P** prismatic

### LED array

**30FX** 3000K

**30LO** 3000K

**30HI** 3000K

**35FX** 3500K

**35LO** 3500K

**35HI** 3500K

**40FX** 4000K

**40LO** 4000K

**40HI** 4000K

### powerhead finish

**AN** silver anodized

**ANB** anodized black

### painted finish

**BR** brick red

**BU** blue

**BZ** bronze

**CP** champagne

**MB** military blue

**MN** mint

**MW** matte white

**OR** orange

**RD** red

**SS** satin silver

**TG** textured gray

**TW** textured white

**YO** yellow

### options

**BKPC** Black power cord and canopy

**SBPC** Silver braid power cord and white canopy

**VHS** 2-point vertical hanging system

**BL** Frosted acrylic bottom lens, solvent welded.

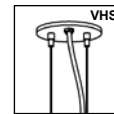

### premium finish

**RAL** specify RAL#

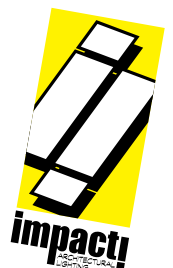

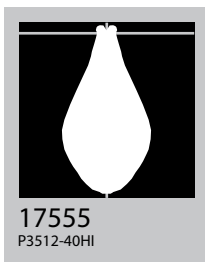
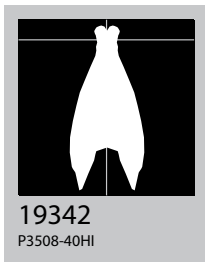
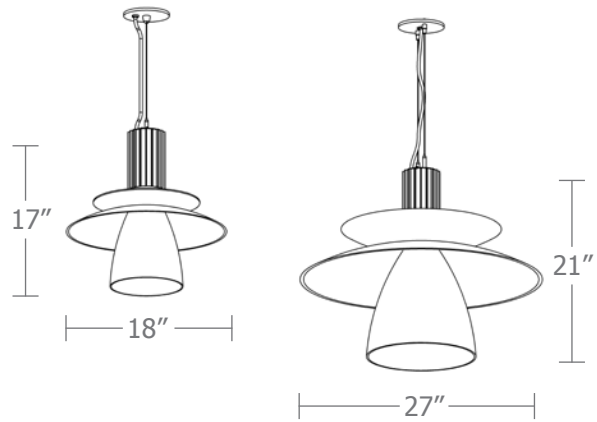

Cat No	Delivered Lumens	Watts		Amps	
		120V	277V	120V	277V
<b>P8718 FX</b>		17	17	.17	.07
4000K	1475				
3500K	1386				
3000K	1268				
<b>P8718 LO</b>		27	27	.23	.10
4000K	2158				
3500K	2029				
3000K	1856				
<b>P8718 HI</b>		35	35	.29	.13
4000K	3348	ies file # 19342			
3500K	3147				
3000K	2879				
<b>P8727 FX</b>		17	17	.17	.07
4000K	1407				
3500K	1322				
3000K	1210				
<b>P8727 LO</b>		27	27	.23	.10
4000K	2059	ies file # 17549			
3500K	1850	ies file # 17554			
3000K	1770				
<b>P81727 HI</b>		35	35	.29	.13
4000K	3277	ies file # 17555			
3500K	3080				
3000K	2818				

## Powder Coat Paint Finishes

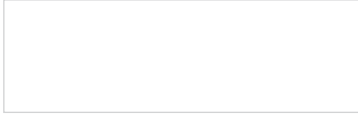

**MW** matte white

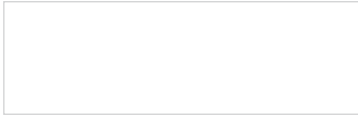

**TW** textured white

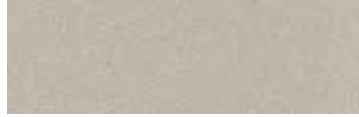

**CP** champagne



**YO** yellow 1018



**RD** red 3020



**BZ** bronze



**BU** blue 5017



**SS** satin silver



**BR** brick red



**OR** orange 2011



**TG** textured gray



**MB** military blue



**MN** mint 6019

For accurate color verification, actual finish samples are available upon request.

## Premium Finishes\*



**RAL#**

For accurate color verification, actual finish samples are available upon request.

\*Available on select series. Consult product spec sheet for availability.

