

job name:
 type:

mel.o™ spec sheet

driver housing / power head

extruded aluminum with silver anodized or black anodized finish, acts as heat sink as well. also available in painted finishes listed below.

diffuser

.25" parabolic matte white acrylic with .125" top acrylic dome available in a variety of colors.

bottom lens (optional)

P95 frosted acrylic bottom lens solvent welded to bottom of parabolic diffuser.

LED module

COB array in 2700K, 3000K, 3500K, or 4000K. (call factory for 5000K) (80+ cri standard) optional 90cri (see below). under normal operating conditions, the LEDs employed are rated for >50,000hrs L70 (6.8K) per IES TM-21 from LM-80 test data.

driver

integral, programmable, UL class P, class 2, universal input (120-277v), constant current, 0-10v dimming, 1% minimum dimming level, PF >.9, THD <20%, protections include open and short circuit, overload and over temperature.

mounting

5" dia. spun steel canopy in satin white with single or dual stainless steel cables and field adjustable grippers that allow for exact AFF mounting heights.

premium mountings

colored cloth cord (optional)

extruded aluminum canopy painted to match fixture. ultrathin vertical stainless steel cable and field adjustable gripper that allow for exact AFF mounting heights. cloth-covered power cord color options listed below. cord requires special stripping tool (link).

power over cable (optional)

extruded aluminum canopy painted to match fixture. Class 2 LED powered suspension system that suspends and powers the fixture with thin stainless steel copper-core conductive cables, providing a clean look without the need for a separate power cord. powered suspension requires cable cutter (link) specifically designed to cut stainless steel aircraft cable from 1/32" to 1/8".

emergency

recommend use of inverter (by other). optional WREM: wired for remote EM battery (by other). if using WHPC, SBPC, or BKPC cords, 2nd power cord required.



catalog number

--	--	--	--	--	--	--

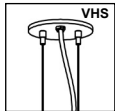
size	top dome	CCT	lumens	powerhead finish	power cord	options
P8112 12"dia X 17"ht	A amber	27 2700K	FX 1750 lm	AN silver anodized	WHPC white power cord and canopy	3FT 36" cable
	B blue	30 3000K	LO 2500 lm	ANB anodized black	BKPC black power cord and canopy	6FT 72" cable
	W white	35 3500K	HI 3200 lm	Painted finish	SBPC silver braid power cord and white canopy	12FT 144" cable*
P8118 18"dia X 21"ht		40 4000K	HX 4350 lm	BN brown	premium (driver canopy required) (not available w/ 12ft option)	90CRI
			CL* xxxx lm <small>*custom lumens consult factory</small>	BR brick red	BUPC blue cloth cord	BL frosted acrylic bottom lens, solvent welded.
				BS brass	ORPC orange cloth cord	VHS 2-point vertical hanging system
				BU blue	PLPC purple cloth cord	WREM wired for remote EM battery pack (by other) (see note above)
				BZ bronze	RDPC red cloth cord	<small>*not available with premium power cords</small>
				CP champagne	WGPC white & gray dot cloth cord	
				GM gun metal	POC power over cable	
				GR green		
				MB military blue		
				MN mint		
				MW matte white		
				OR orange		
				PL purple		
				RD red		
				SS satin silver		
				TG textured gray		
				TW textured white		
				YO yellow		

premium finish

RAL specify RAL#

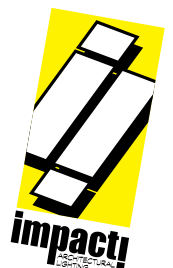

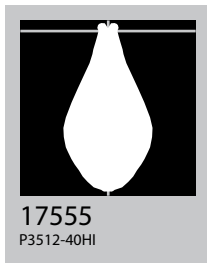
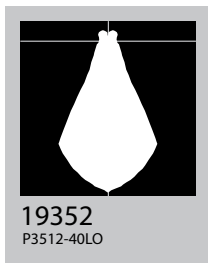
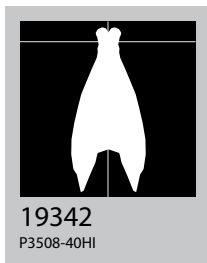
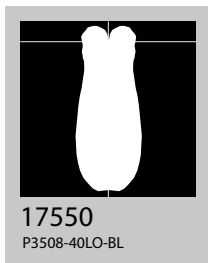
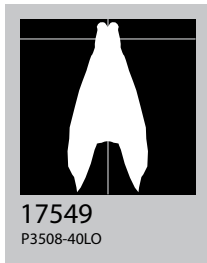
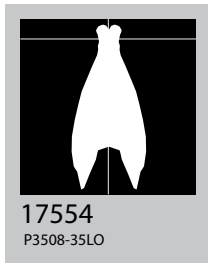
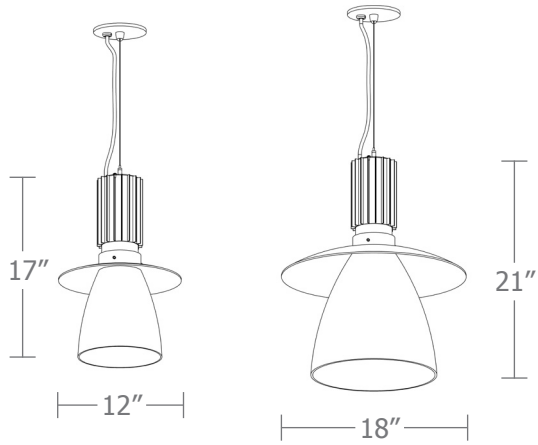

Watts **Amps**
Cat No **Delivered Lumens*** **120V / 277V** **120V** **277V**

Cat No	Delivered Lumens*	Watts 120V / 277V	Amps 120V	Amps 277V
P8112 FX	1750	14	.12	.05
P8112 LO	2500	20	.17	.07
ies file # 17549, # 17550**, # 17554				
P8112 HI	3200	29	.24	.10
ies file # 19342 & # 19343**				
P8112 HX	4350	38	.32	.14
P8118 FX	1750	14	.12	.05
P8118 LO	2500	20	.17	.07
ies file # 19352				
P8118 HI	3200	29	.24	.10
ies file # 17555				
P8118 HX	4350	38	.32	.14

*delivered lumens based on 4000K, 80+ cri (90cri multiplier .83)

**includes bottom lens option (BL multiplier .90)

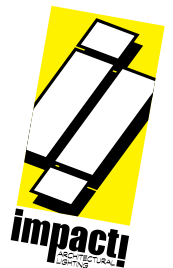

Powder Coat Paint Finishes

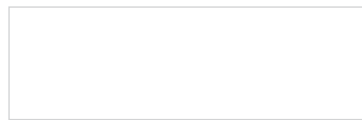

MW matte white



CP champagne



YO yellow 1018

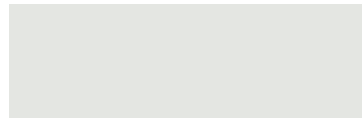

TW textured white

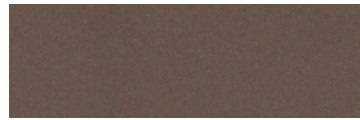

BZ bronze



RD red 3020



BS brass



BU blue 5017

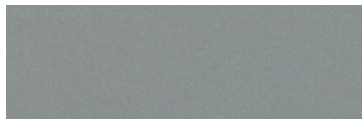

SS satin silver

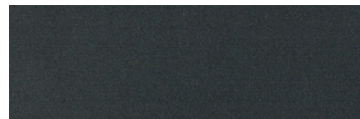

GM gun metal



OR orange 2011

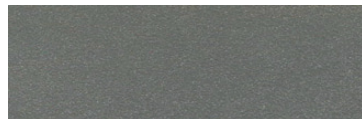

TG textured gray



BR brick red



MN mint 6019



BN brown 8023



GR green 6018



MB military blue



PL purple 4005

For accurate color verification, actual finish samples are available upon request.

Premium Finishes*



RAL#

*Available on select series. Consult product submittal for availability.

