

job name:
 type:

miniskrt LED™ spec sheet

material

housing

precision CNC spun .064" aluminum outer housing available in 15 standard powder coat paint finishes listed below.
 .060" aluminum liner powder coat painted high reflectance matte white.

diffuser

choose from .125" white acrylic or .064" spun aluminum powder coat painted high reflectance matte white.

LED

custom LED board in 3000K, 3500K, or 4000K (80 cri) (90 cri available upon request) employing Samsung 281B mid power LEDs. LEDs are rated >50,000 hours L70 (10K) at 85°C per LM-80 test data, and 70,000 hours projected life per IES TM-21. power cord color options listed below.

driver

in canopy, constant current, class P class 2 power unit, class A sound rating, universal input (120-277V) programmable driver; 1% minimum dimming level, PF >0.90. protections include short circuit, input/output isolation and surge protection (3KV). wired for 0-10v dimming from factory.

mounting

spun aluminum canopy painted to match fixture. three ultrathin vertical stainless steel cables and field adjustable grippers that allow for exact AFF mounting heights.

power over cable (optional)

Class 2 LED powered suspension system that suspends and powers the fixture with thin stainless steel copper core conductive cables, providing a clean look without the need for a separate power cord.

finish

select from standard powder coat paint finishes or specify RAL# for custom colors.

emergency

if required, recommend use of inverter (by other).



catalog number

<input type="text"/>	<input type="text"/>	<input type="text"/>	<input type="text"/>	<input type="text"/>	<input type="text"/>
----------------------	----------------------	----------------------	----------------------	----------------------	----------------------

size	diffuser	LED	standard finishes	power cord	cable length
P6112 12.5"dia X 4.5"ht	A acrylic M metal	30LO 3000K 30HI 3000K 35LO 3500K 35HI 3500K 40LO 4000K 40HI 4000K	AP anodized paint BR brick red BU blue BZ bronze CP champagne MB military blue MN mint MW matte white OR orange RD red SB satin black SS satin silver TG textured gray TW textured white YO yellow	BUPC blue cloth cord ORPC orange cloth cord PLPC purple cloth cord RDPC red cloth cord WGPC white & gray dot cloth cord POC power over cable	3FT 6FT

Premium Finish

RAL specify RAL#



DRY / DAMP
pending

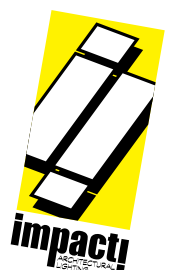

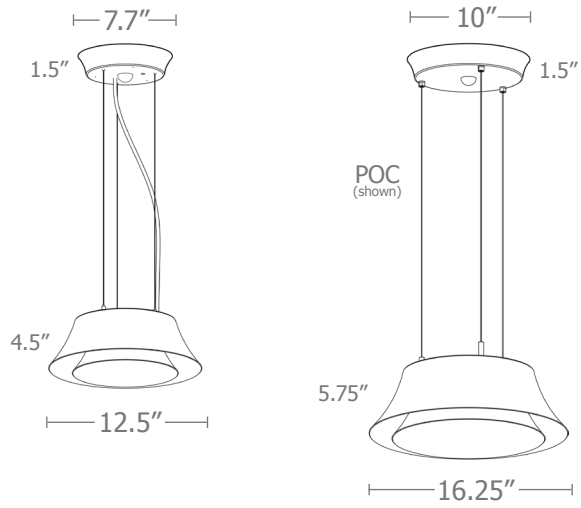

Cat No	HI	Watts	LO	Watts
P6112 - A	1830	23	770	10
P6112 - M	1000	23	420	10
P6116 - A	2750	34	1830	23
P6116 - M	1500	34	1000	23

*Preliminary delivered lumens

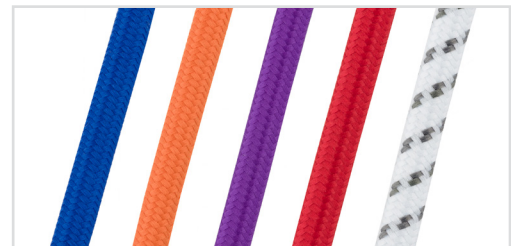

Powder Coat Paint Finishes

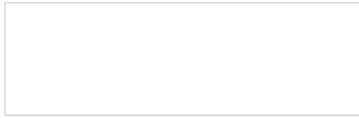

MW matte white



SB satin black



YO yellow 1018

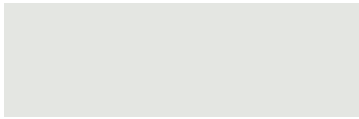

TW textured white



CP champagne



RD red 3020



AP anodized paint

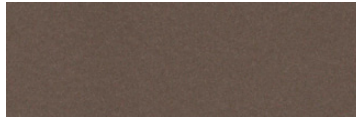

BZ bronze



BU blue 5017

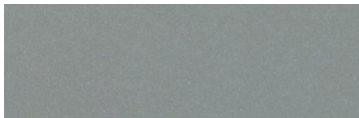

SS satin silver



BR brick red



OR orange 2011

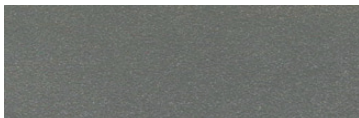

TG textured gray



MB military blue



MN mint 6019

For accurate color verification, actual finish samples are available upon request.

Premium Finishes*



RAL#

*Available on select series. Consult product submittal for availability.

